

BRETTON

PRODUTOS
2021

MESAS LATERAIS	2
MESAS DE CENTRO	19
POLTRONAS E NAMORADEIRA	35
CADEIRAS	72
BANCOS	97
CHAISES	104
ESPREGUIÇADEIRAS	110
PUFFS	113
SOFÁS	119
APARADORES	139
MESAS DE JANTAR	144
BUFFETS E BARES	152
COMPLEMENTOS	161
HOMES	175

MESAS LATERAIS

PRODUTOS
2021

MESA LATERAL **CIRCULOS**

COLEÇÃO **CANADÁ**



DESIGNER

Murilo
Weitz

MATERIAL

Estrutura Jasper
Tampas Etrusco Off White

DIMENSÕES

Largura: 80cm
Profundidade: 74cm
Altura: 45cm

BRETON



MESA LATERAL VITÓRIA REGIA

COLEÇÃO CANADÁ



DESIGNER

Rapha
Preto

MATERIAL

Tampo carvalho ebanizado
Base jasper

DIMENSÕES

Largura: 50cm
Profundidade: 50cm
Altura: 40cm



BRETON

MESA LATERAL PUGLIA

COLEÇÃO CANADÁ



DESIGNER

Diogo
Giácomo

DIMENSÕES

Quadrada :

Largura: 30cm
Profundidade: 30cm
Altura: 57,5cm

Redonda :

Largura: 30cm diâmetro
Profundidade: 30 cm diâmetro
Altura: 57,5cm

Triangular :

Largura: 28cm
Profundidade: 31,5cm
Altura: 57,5cm

MATERIAL

Bandeja em chapa metálica com
pintura eletrostática
Barra de aço com pintura
eletrostática preto
Base em concreto alisado
com verniz fosco



BRETON

MESA LATERAL BARRA

COLEÇÃO CANADÁ



DESIGNER

Diogo Giácomo

MATERIAL

Estrutura em aço carbono
ou inox polido
Acabamento em lâmina ou laca
Tampo superior em mdf laminado,
pintado ou mármore
Tampo inferior em mármore
base em aço carbono pintado
ou inox polido

DIMENSÕES

Largura: 35cm diâmetro
Profundidade: 35cm diâmetro
Altura: 57cm



BRETON

MESA LATERAL **CARAÍVA**

COLEÇÃO BRASIL



DESIGNER

Luisa Moysés

MATERIAL

Estrutura em ouro velho
Tampas em mdf laminado

DIMENSÕES

Largura:
Profundidade:
Altura:



BRETON

MESA LATERAL DIAMANTINA

COLEÇÃO BRASIL

BRETON



DESIGNER
Luisa Moysés

MATERIAL

Estrutura em ouro velho
Tampo em mármore

DIMENSÕES

Largura:
Profundidade:
Altura:



MESA LATERAL MILAGRES

COLEÇÃO BRASIL



DESIGNER
Luisa Moysés

MATERIAL

Estrutura em ouro velho
Tampo em palha
Detalhes em madeira maciça

DIMENSÕES

Largura:
Profundidade:
Altura:



BRETON



MESA LATERAL **OLODUM**

COLEÇÃO **CANADÁ**



DESIGNER
Luisa Moysés

MATERIAL

Estrutura em aço carbono pintado,
inox polido ou inox tonalizado.
Tampo superior em madeira ou vidro.
Tampo inferior em madeira ou mármore.

DIMENSÕES

Largura: 50cm
Profundidade: 38cm
Altura: 62cm



BRETON

MESA LATERAL IPÊ

COLEÇÃO BRASIL

DESIGNER

Eduardo Marques

MATERIAL

Estrutura em ouro velho ou onix
Tampo em madeira ebanizada
Tampo inferior em mármore ou
madeira ebanizada

DIMENSÕES

Largura:
Profundidade:
Altura:

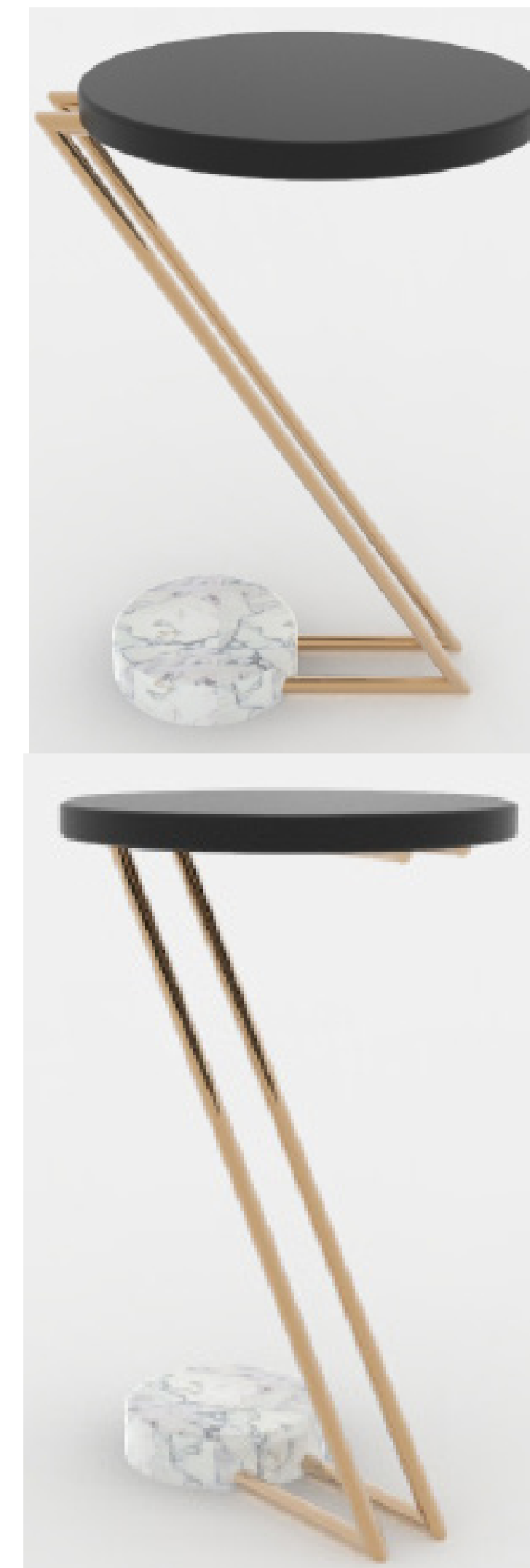

BRETON

MESA LATERAL **KINOSHITA**

COLEÇÃO JAPÃO

MATERIAL

Pés em madeira ou laca.
Tampo em madeira ou laca.
Moldura em carvalho, noqueira,
vidro ou espelho.

DIMENSÕES

Largura: 60cm de diâmetro
Profundidade: 60cm de diâmetro
Altura: 60cm



MESA LATERAL **CHIBA**

COLEÇÃO JAPÃO

MATERIAL

Pés em madeira ou laca.
Tampo em carvalho, nogueira ou laca.

DIMENSÕES

Largura: 60 ou 80cm de diâmetro.
Profundidade: 60 ou 80cm de diâmetro
Altura: 60cm



MESA LATERAL **SUSHI**

COLEÇÃO JAPÃO

MATERIAL

Base em carvalho, nogueira ou laca.
Tampas em carvalho, nogueira,
laca ou vidro.
Haste em alumínio pintado.

DIMENSÕES

Largura: 40cm de diâmetro
Profundidade: 40cm de diâmetro
Altura: 76cm



MESA LATERAL LENTE

COLEÇÃO ISRAEL



DESIGNER
Felipe Piccelli

MATERIAL

Estrutura em mdf
Tampo em recouro
Acabamento em laca fosca
Base em metal revestido com recouro

DIMENSÕES

Largura: 50cm diâmetro
Altura: 48cm/58cm



MESA LATERAL **RAINHA**

COLEÇÃO **CANADÁ**



DESIGNER

Reinaldo Lourenço

MATERIAL

Estrutura em mdf laminado
ou aço inox polido
Tampo em mdf laminado

DIMENSÕES

Largura: 74cm
Profundidade: 74cm
Altura: 60cm



MESA LATERAL **SANTA MARIA**

COLEÇÃO **CANADÁ**

DESIGNER

Marlene Ricci

MATERIAL

Tampo em madeira, muxarabi ou laca
Estrutura em ouro velho;

DIMENSÕES

Largura : 80cm
Profundidade : 80cm
Altura : 40cm ou 50cm

BRETON



MESA LATERAL **CABRAS**

COLEÇÃO COLÔMBIA

DESIGNER

Fernanda Marques

MATERIAL

DIMENSÕES

Largura:
Profundidade:
Altura:



BRETON

MESAS DE CENTRO

PRODUTOS
2021

MESA DE CENTRO **MINATO**

COLEÇÃO JAPÃO

MATERIAL

Pés em carvalho, noqueira ou laca.
Tampo em carvalho, noqueira ou laca.
Moldura com vidro, espelho, couríssimo
ou porcelana.

DIMENSÕES

800 ø350	900x900x300
900 ø300	1000x1000x250
1000 ø250	1200x1200x250
1200 ø250	
1800x600x350	
1800x600x250	
800x800x350	



MESA DE CENTRO RETANGULAR **MINATO**

COLEÇÃO JAPÃO



MATERIAL

Pés em carvalho, noqueira ou laca.
Tampo em carvalho, noqueira ou laca.
Moldura com vidro, espelho, couríssimo
ou porcelana.

DIMENSÕES

Largura: 180cm
Profundidade: 60cm
Altura: 30cm

MESA DE CENTRO **SANTA MARIA**

COLEÇÃO **CANADÁ**

BRETON



DESIGNER

Marlene Ricci

MATERIAL

Tampo em madeira ou madeira e vidro
ou muxarabi.
Estrutura em ouro velho;

DIMENSÕES

Largura : 200cm
Profundidade : 90cm
Altura : 35cm



MESA DE CENTRO **JUNIA**

COLEÇÃO **BRASIL**



DESIGNER
Pedro Mendes

MATERIAL

DIMENSÕES

BRETON

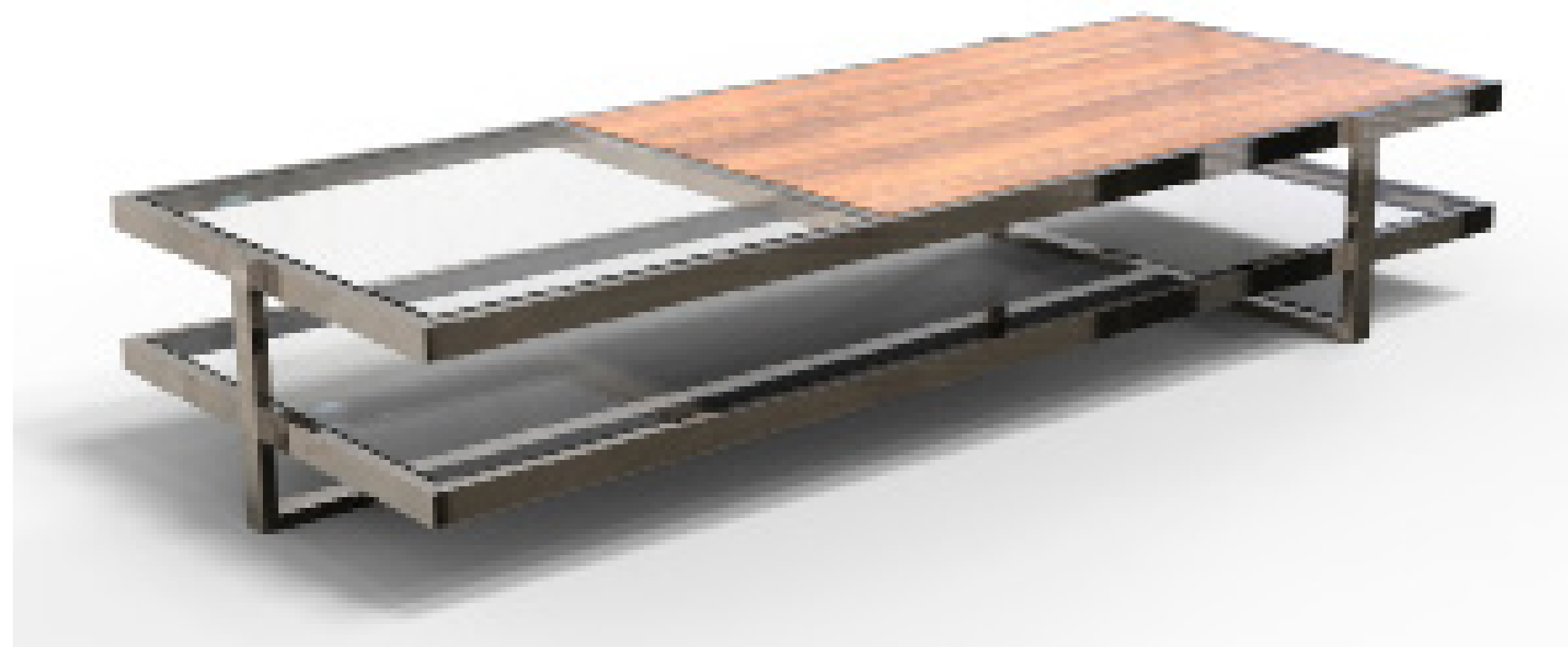

MESA DE CENTRO INTER

COLEÇÃO BRASIL



DESIGNER
Suite Arquitetos

MATERIAL

Tampo em pedra e estrutura em mdf revestido.

DIMENSÕES

Largura: 120 ou 180cm
Profundidade: 80 ou 120cm
Altura: 36cm

BRETON



MESA DE CENTRO **AMANA**

COLEÇÃO BRASIL



DESIGNER
Alê Alvarenga

MATERIAL

DIMENSÕES

BRETON

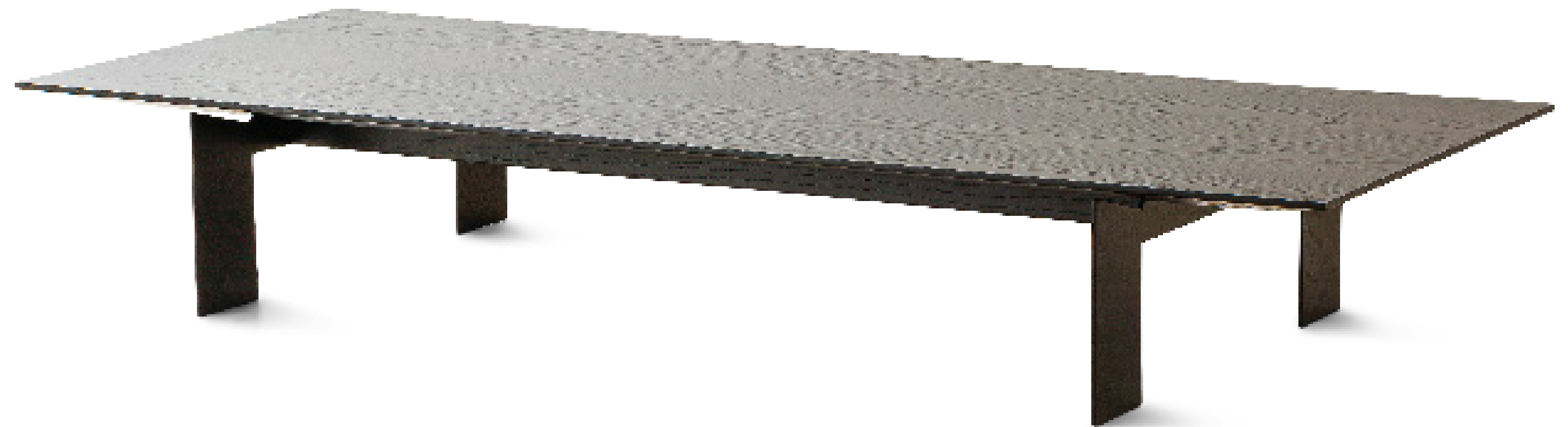

MESA DE CENTRO VITÓRIA REGIA

COLEÇÃO CANADÁ

BRETON



DESIGNER
Rapha Preto

MATERIAL

Estrutura jasper
Tamos em nogueira

DIMENSÕES

Largura: 87cm
Profundidade: 87cm
Altura: 25cm



MESA DE CENTRO **RAINHA**

COLEÇÃO **CANADÁ**

BRETON



DESIGNER

Reinaldo Lourenço

MATERIAL

Estrutura em aço carbono polido
ou inox pintado.
Acabamento em lâmina, laca ou cimento.

DIMENSÕES

Largura: 90cm
Profundidade: 150cm
Altura: 35cm



MESA DE CENTRO **DAMA**

COLEÇÃO BRASIL



DESIGNER
Reinaldo Lourenço

MATERIAL

DIMENSÕES

BRETON



MESA DE CENTRO **CIRCULOS**

COLEÇÃO **CANADÁ**



DESIGNER
Murilo Weitz

MATERIAL

Base etrusco cinza escuro
Tampo reflecta fume

DIMENSÕES

Largura: 160cm
Profundidade: 110cm
Altura: 40cm

BRETON



MESA DE CENTRO **ANAHI**

COLEÇÃO BRASIL



DESIGNER
Alê Alvarenga

MATERIAL

DIMENSÕES

BRETON

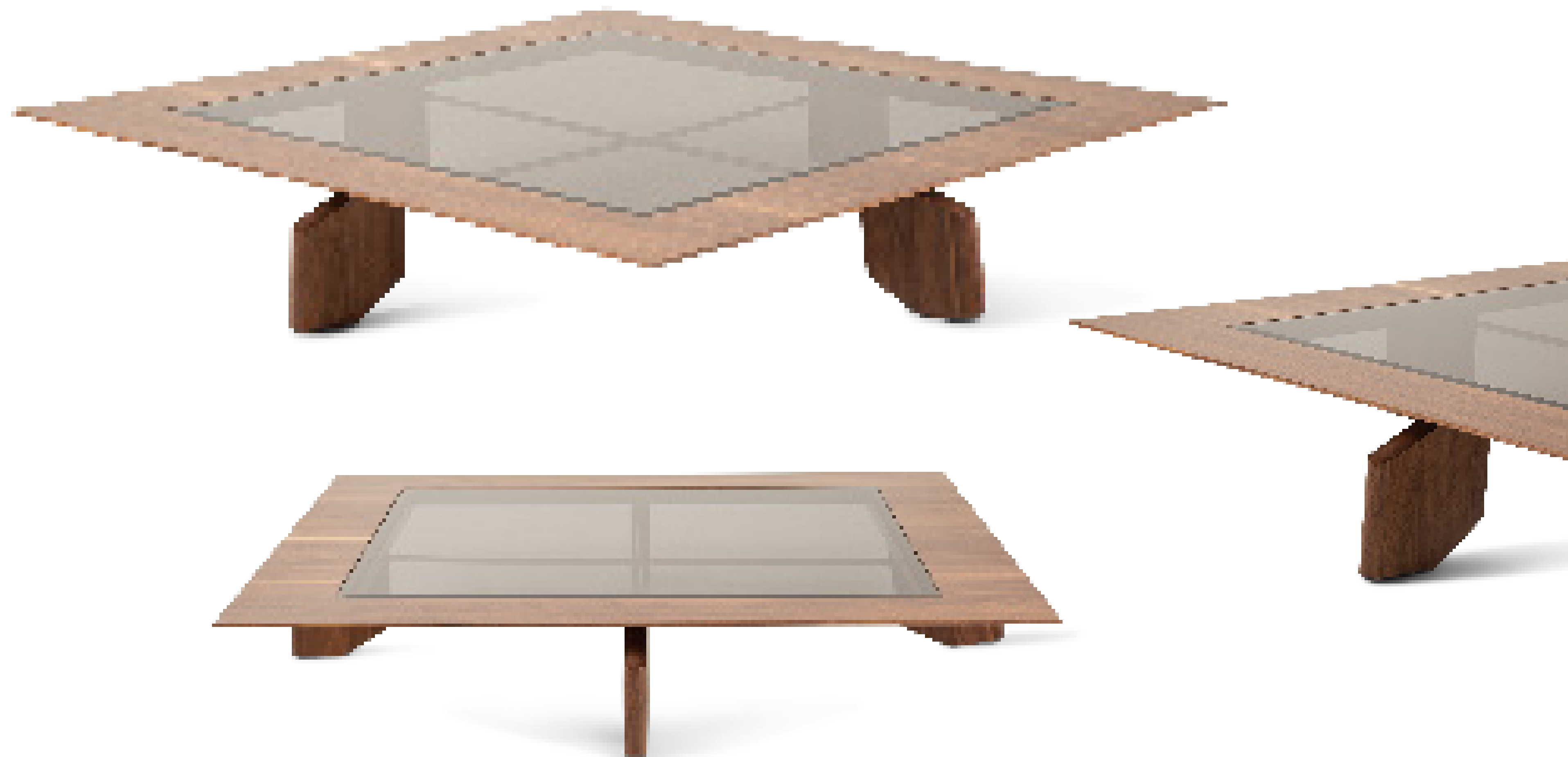

MESA DE CENTRO **LEBLON**

COLEÇÃO BRASIL



DESIGNER
Diogo Giácomo

MATERIAL

DIMENSÕES

Largura:
Profundidade:
Altura:

BRETON



MESA DE CENTRO **CUNHA**

COLEÇÃO BRASIL



DESIGNER
Karol Suguikawa

MATERIAL

DIMENSÕES

BRETON



MESA DE CENTRO **HEIFA**

COLEÇÃO ISRAEL

MATERIAL

Base e laterais em recouro, tampo revestido em espelho ou vidro colorido, bisotê do tampo em laminação facetada

DIMENSÕES

Largura: 100 até 140cm
Profundidade: 100 até 140cm
Altura: 30cm

BRETON



MESA DE CENTRO **KENOA**

COLEÇÃO **BRASIL**



DESIGNER

Luisa Moysés

MATERIAL

DIMENSÕES

BRETON



MESAS DE CENTRO **MONOLITO**

COLEÇÃO BRASIL



DESIGNER

Eminência
em Preto

MATERIAL

Madeira e mármore.

DIMENSÕES

Largura : 150cm/160cm/160 diâmetro
Profundidade : 150cm/50cm
Altura : 14cm

BRETON

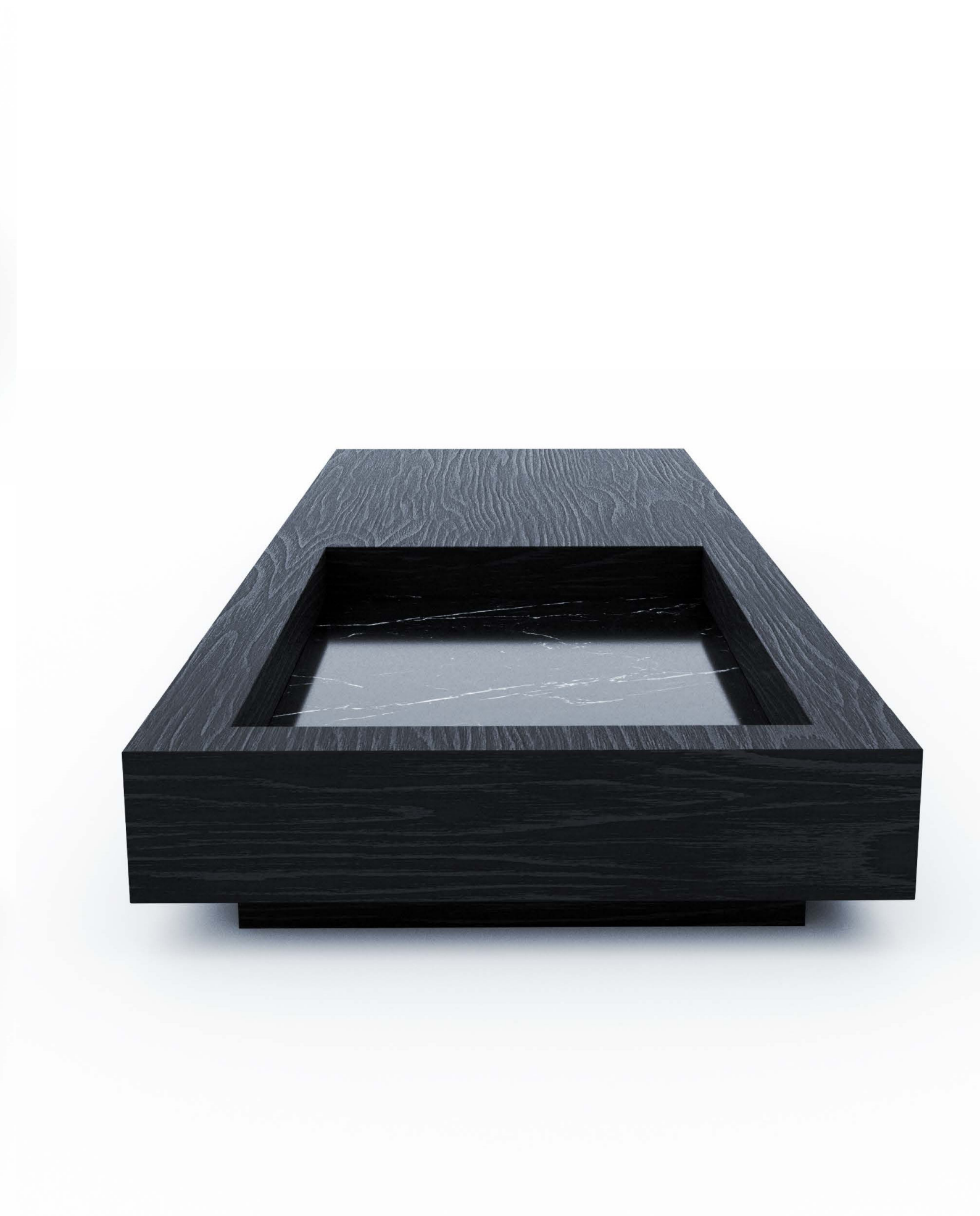
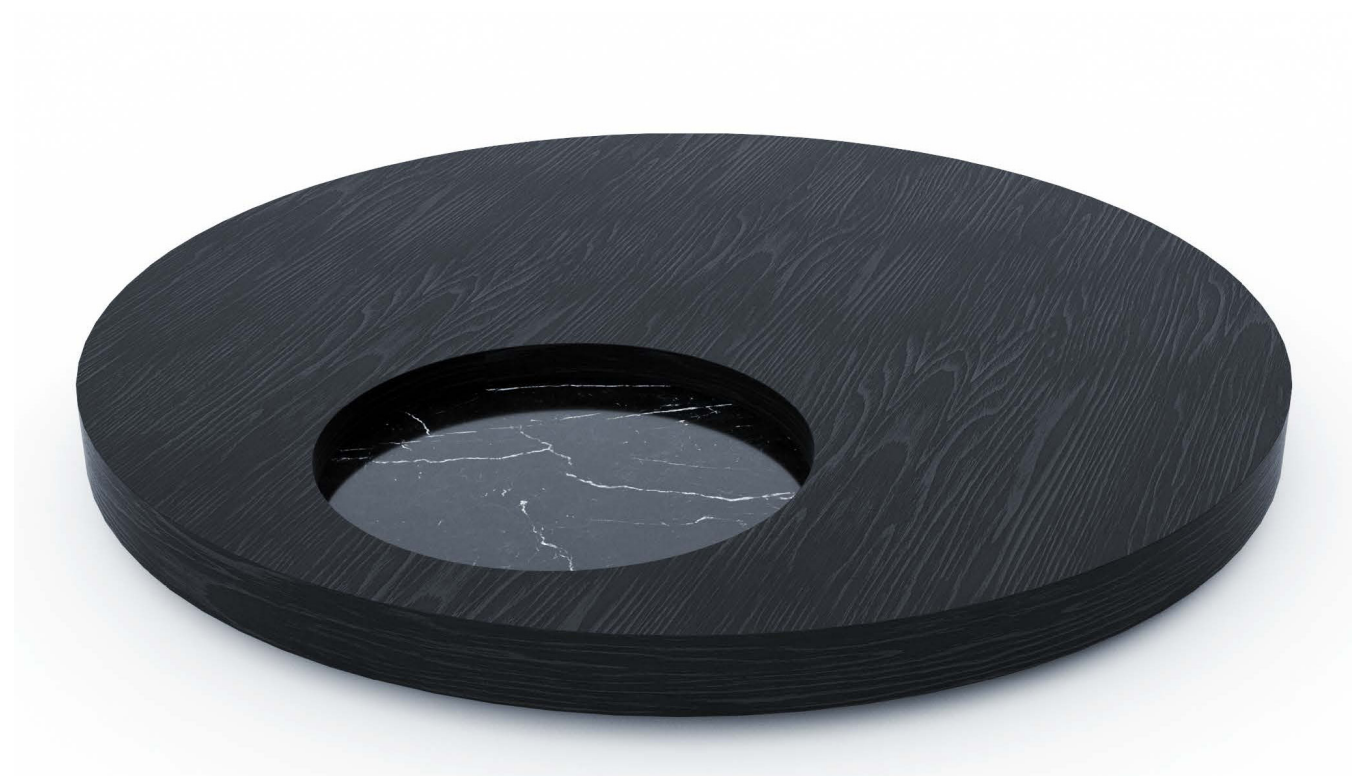

MESA DE CENTRO **LUNAS**

COLEÇÃO **CARIBE**

MATERIAL
Madeira Freijó

DIMENSÕES
Largura:100cm
Profundidade:60cm
Altura:17cm

BRETON



MESA DE CENTRO **INDAIA**

COLEÇÃO COLÔMBIA

DESIGNER

Fernanda Marques

MATERIAL

DIMENSÕES

Largura:
Profundidade:
Altura:

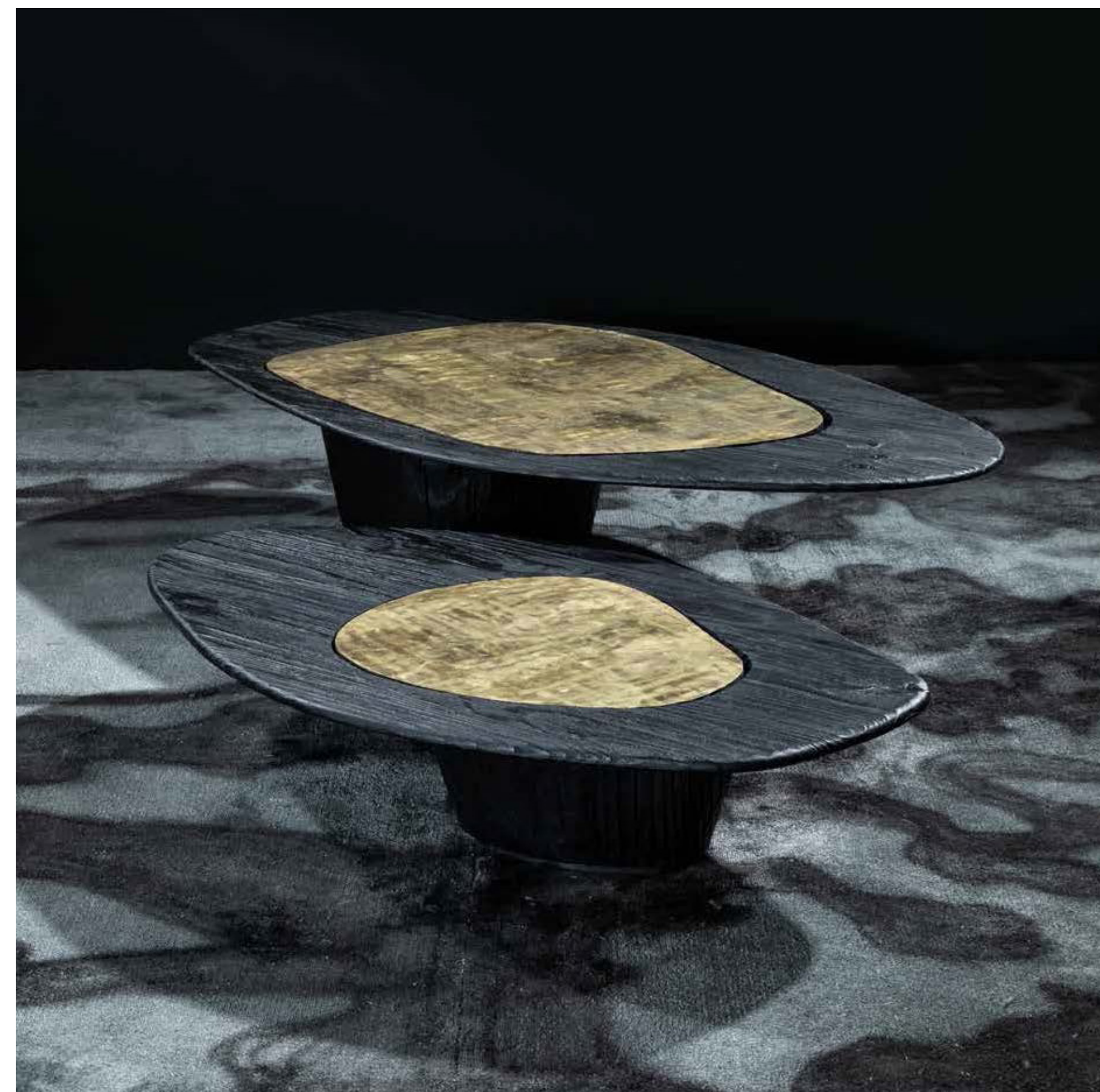

BRETON



POLTRONAS
E NAMORADEIRA

PRODUTOS
2021

POLTRONA AGOGO

COLEÇÃO PORTUGAL



DESIGNER

Lilly e Renata Sarti

MATERIAL

Estrutura em eucalipto.
Revestimento conforme mostrário
Base em madeira ou aço carbono

DIMENSÕES

Largura: 91cm
Profundidade: 85cm
Altura: 68cm

PUFF

Largura: 56cm
Profundidade: 56cm
Altura: 38cm



BRETON



POLTRONA BUMBO

COLEÇÃO PORTUGAL



DESIGNER

Lilly e Renata Sarti

MATERIAL

Assento e encosto fixo,
sem detalhe de costura.

DIMENSÕES

Largura: 80cm
Profundidade: 85cm
Altura: 42cm



BRETÓN



NAMORADEIRA JIBOIA

COLEÇÃO FRANÇA



DESIGNER

Bianca Barbato

MATERIAL

Estrutura em fibra de vidro, base em aço carbono pintado ou banho metálico, assento com espuma densidade 26. Assento em madeira pinus de reflorestamento.

DIMENSÕES

Largura: 159cm
Profundidade: 75cm
Altura: 76cm

BRETON



POLTRONA **GALEGA**

COLEÇÃO BRASIL



DESIGNER
André Grippi

MATERIAL

DIMENSÕES

BRETON



POLTRONA ATHOS

COLEÇÃO **BÉLGICA**



DESIGNER

Eminência
em Preto

MATERIAL

Assento e Encosto em multilaminado de madeira,
totalmente estofada
Base em Aço Carbono Pintado

DIMENSÕES

Largura: 67cm
Profundidade: 77cm
Altura: 108cm



BRETON

POLTRONA APOLO

COLEÇÃO BÉLGICA



DESIGNER

Eminência
em Preto

MATERIAL

Assento em madeira estofada, encosto
em multilaminado de madeira estofado
Base em aço carbono em barra chata
pintada

DIMENSÕES

Largura: 74cm
Profundidade: 61cm
Altura: 70cm



BRETON

POLTRONA LIP

COLEÇÃO **BÉLGICA**



DESIGNER

Edu Bortolai

MATERIAL

Concha em madeira multilaminada estofada
Estrutura em madeira eucalipto tingida

DIMENSÕES

Largura: 63cm
Profundidade: 62cm
Altura: 86cm



BRETON



POLTRONA CILINDROS

COLEÇÃO PORTUGAL



DESIGNER
MURILO
WEITZ

MATERIAL

DIMENSÕES

Largura: 75cm
Profundidade: 77cm
Altura: 63cm

BRETON



POLTRONA **DONDOLO**

COLEÇÃO COSTA RICA



DESIGNER
BRUNO
JAHARA

MATERIAL

ESTRUTURA AÇO
INOX
ESTOFADO CORANO
PRETO

DIMENSÕES

LARGURA: 68cm
PROFUNDIDADE: 71cm
ALTURA: 65cm

BRETON



POLTRONA MAYA

COLEÇÃO BRASIL



DESIGNER
ALE
ALVARENGA

MATERIAL

DIMENSÕES

Largura:
Profundidade:
Altura:



BRETON

POLTRONA **PALMA**

COLEÇÃO ARGENTINA

DESIGNER

Bruno Simões

MATERIAL

DIMENSÕES

Largura:
Profundidade:
Altura:

BRETON



POLTRONA TRÓPICO

COLEÇÃO ALEMANHA



DESIGNER
BRUNO SIMÕES

MATERIAL

Estrutura em madeira maciça.
Revestimento conforme mostruário
Braços em madeira maciça
Pés em madeira maciça açoita-cavalo

DIMENSÕES

Largura: 77cm
Profundidade: 79cm
Altura: 82cm

BRETON



POLTRONA TRANCOSO

COLEÇÃO BRASIL

BRETON



DESIGNER

Luisa Moysés

MATERIAL

DIMENSÕES

Largura:
Profundidade:
Altura:



POLTRONA ETTIENE

COLEÇÃO ALEMANHA

MATERIAL

Estrutura em madeira maciça.
Revestimento em tecido ou couro.
Almofada em fibra manta.
Base giratória em alumínio

DIMENSÕES

Largura:76cm
Profundidade:73cm
Altura:78cm

BRETON



POLTRONA NICE

COLEÇÃO FRANÇA

MATERIAL

Estrutura em fibra de vidro, base em aço carbono pintado ou banho metálico, assento com espuma densidade 26. Assento em madeira pinus de reflorestamento

DIMENSÕES

Largura: 97cm
Profundidade: 80cm
Altura: 80cm

BRETON



POLTRONA **CANNES**

COLEÇÃO FRANÇA

MATERIAL

Estrutura em fibra de vidro, base em madeira pintada, assento com almofada solta e espuma densidade 26.

DIMENSÕES

Largura: 77cm
Profundidade: 82cm
Altura: 85cm



BRETON

POLTRONA **PROVENCE**

COLEÇÃO FRANÇA

MATERIAL

Estrutura e base giratória em aço carbono pintado ou banho metálico, assento com espuma densidade 26. Assento em madeira pinus de reflorestamento

DIMENSÕES

Largura: 71cm
Profundidade :71cm
Altura: 83cm

BRETON



POLTRONA SANTA BÁRBARA

COLEÇÃO ESTADOS UNIDOS

BRETON



MATERIAL

Estrutura em pinus, duratex, espuma D28 e manta acrílica. Encosto e assento em compensado anatômico, espuma D30 e mola espiral. Base em aço carbono com acabamento laminado e pintado.

DIMENSÕES

Largura: 78cm
Profundidade: 70cm
Altura: 70cm

POLTRONA **CHICAGO**

COLEÇÃO ESTADOS UNIDOS

MATERIAL

Estrutura em pinus, duratex, espuma D20,
manta acrílica.
Encosto e assento em TNT e fibra poliéster
siliconizada.
Base em aço carbono.

DIMENSÕES

Largura: 80cm
Profundidade: 80cm
Altura: 82cm



BRETON

POLTRONA LAKERS

COLEÇÃO ESTADOS UNIDOS

BRETON



MATERIAL

Estrutura em pinus, espuma D28, duratex e fibra poliéster acrílica, compensado e mola espiral.
Base em MDF laminado.

DIMENSÕES

Largura: 85cm
Profundidade: 80cm
Altura: 80cm

POLTRONA LOS ANGELES

COLEÇÃO ESTADOS UNIDOS



DESIGNER
LUAN DEL
SAVIO

MATERIAL

Estrutura em pinus, duratex,
espuma D28 e manta acrílica.
Encosto e assento em alumínio,
espuma D30 e manta acrílica
e percinta elástica
Base em MDF laminado.

DIMENSÕES

Largura: 70cm
Profundidade: 70cm
Altura: 75cm



BRETON

POLTRONA **SAN DIEGO**

COLEÇÃO ESTADOS UNIDOS

MATERIAL

Estrutura em aço carbono e compensado.
Encosto e assento em TNT, espuma D30,
manta acrílica e fibra poliéster siliconizada.
Base em aço carbono.

DIMENSÕES

Largura: 130cm
Profundidade: 85cm
Altura: 80cm



BRETON



POLTRONA LAS VEGAS

COLEÇÃO ESTADOS UNIDOS



DESIGNER
LUAN DEL
SAVIO

MATERIAL

Estrutura em pinus, duratex,
espuma D28 e manta acrílica.
Encosto e assento em alumínio,
espuma D30 e manta acrílica.
Base em MDF laminado.

DIMENSÕES

Largura: 70cm
Profundidade: 70cm
Altura: 75cm



BRETON

POLTRONA **FIDEL**

COLEÇÃO **CUBA**



DESIGNER
GRACIA
MENDES

MATERIAL

ACABAMENTO : TECIDOS VARIADOS
ESTOFADO : ESPUMA DE ALTA DENSIDADE
BASE: AÇO INOX

DIMENSÕES

LARGURA: 80 ATÉ 300CM
PROFUNDIDADE: 90CM
ALTURA: 82CM



POLTRONA RAVELLO

COLEÇÃO IRLANDA



DESIGNER
REJANE
CARVALHO

MATERIAL

ESTRUTURA : MADEIRA MACIÇA
ACABAMENTO : ESTOFARIA EM TECIDO

DIMENSÕES

LARGURA: 730MM
PROFUNDIDADE: 740MM
ALTURA: 915MM

BRETON



POLTRONA HAPI

COLEÇÃO IRLANDA



DESIGNER
LATOOGG

MATERIAL

ESTRUTURA : MADEIRA MACIÇA, MULTILAMINADO
ARO INOX OU MULTILAMINADO
ACABAMENTO : ESTOFARIA EM TECIDO

DIMENSÕES

LARGURA: 960MM
PROFUNDIDADE: 840MM
ALTURA: 960MM

BRETON



POLTRONA BALTHAZAR

COLEÇÃO ESTADOS UNIDOS



DESIGNER
LUAN DEL
SAVIO

MATERIAL

Estrutura em pinus, duratex,
espuma D28, manda acrílica,
aço laminado.
Encosto e assento em TNT, espuma D30
e fibra poliéster siliconizada.

DIMENSÕES

Largura: 90cm
Profundidade: 85cm
Altura: 85cm



BRETON

POLTRONA ORLANDO

COLEÇÃO ESTADOS UNIDOS

MATERIAL

Estrutura em pinus, duratex, espuma D28 e manta acrílica. Encosto e assento em compensado anatômico, espuma D30 e mola espiral. Base em aço carbono com acabamento laminado e pintado.

DIMENSÕES

Largura: 90cm
Profundidade: 77cm
Altura: 78cm



BRETON

POLTRONA MIAMI

COLEÇÃO ESTADOS UNIDOS

MATERIAL

Estrutura em pinus, duratex, espuma D28 e manta acrílica. Encosto e assento em compensada, espuma D30 e percinta elástica. Base em aço carbono com acabamento laminado.

DIMENSÕES

Largura: 90cm
Profundidade: 77cm
Altura: 78cm



BRETON

POLTRONA NEW YORK

COLEÇÃO ESTADOS UNIDOS

MATERIAL

Estrutura em pinus, duratex, espuma D28 e manta acrílica. Encosto e assento em compensado anatômico, espuma D30 e mola espiral. Base em aço carbono com acabamento laminado e pintado.

DIMENSÕES

Largura: 85cm
Profundidade: 75cm
Altura: 80cm



BRETON

POLTRONA JIBOIA

COLEÇÃO FRANÇA



DESIGNER

Bianca Barbato

MATERIAL

Estrutura de encosto em fibra de vidro, base em aço carbono pintado ou banho metálico, assento com espuma densidade 26. Assento em madeira pinus de reflorestamento

DIMENSÕES

Largura: 100cm
Profundidade: 75cm
Altura: 76cm



BRETON

POLTRONA BEVERLY

COLEÇÃO ESTADOS UNIDOS

MATERIAL

Estrutura em aço carbono pintado na cor preta.
Tecido conforme mostruário.
Braços e assento em madeira.

DIMENSÕES

Largura: 82cm
Profundidade: 85cm
Altura: 77cm



BRETON

POLTRONA QUEZON

COLEÇÃO FILIPINAS

MATERIAL

Estrutura em tubo de alumínio com pintura eletrostática; Revestimento em corda trançada náutica. Encosto e assento em espuma D28, manta acrílica e TNT

DIMENSÕES

Largura: 101cm
Profundidade: 91cm
Altura: 100cm



BRETON

POLTRONA **VERUS**

COLEÇÃO **COSTA RICA**



DESIGNER

Reinaldo Lourenço

MATERIAL

Estrutura em aço carbono pintado.
Revestimento conforme solicitação.

DIMENSÕES

Largura: 113cm
Profundidade: 72cm
Altura: 68cm



POLTRONA LUXOR

COLEÇÃO EGITO

MATERIAL

Estrutura em aço galvanizado tratado e pintura eletrostática.
Revestimento tramado em corda náutica.

DIMENSÕES

Largura: 95cm
Profundidade: 95cm
Altura: 140cm



BRETON

CADEIRAS

PRODUTOS
2021

CADEIRA **ALFRED**

COLEÇÃO **CROÁCIA**



DESIGNER
Eminência
em Preto

MATERIAL

Estrutura em madeira jequitibá rosa.
Tecido conforme mostruário.

DIMENSÕES

Largura: 57cm
Profundidade: 82cm
Altura: 78cm



BRETON

CADEIRA BARRA DO UNA

COLEÇÃO BRASIL

MATERIAL

DIMENSÕES

Largura:
Profundidade:
Altura:



BRETON



CADEIRA **BARRA DO SAHY**

COLEÇÃO BRASIL

MATERIAL

DIMENSÕES

Largura:
Profundidade:
Altura:

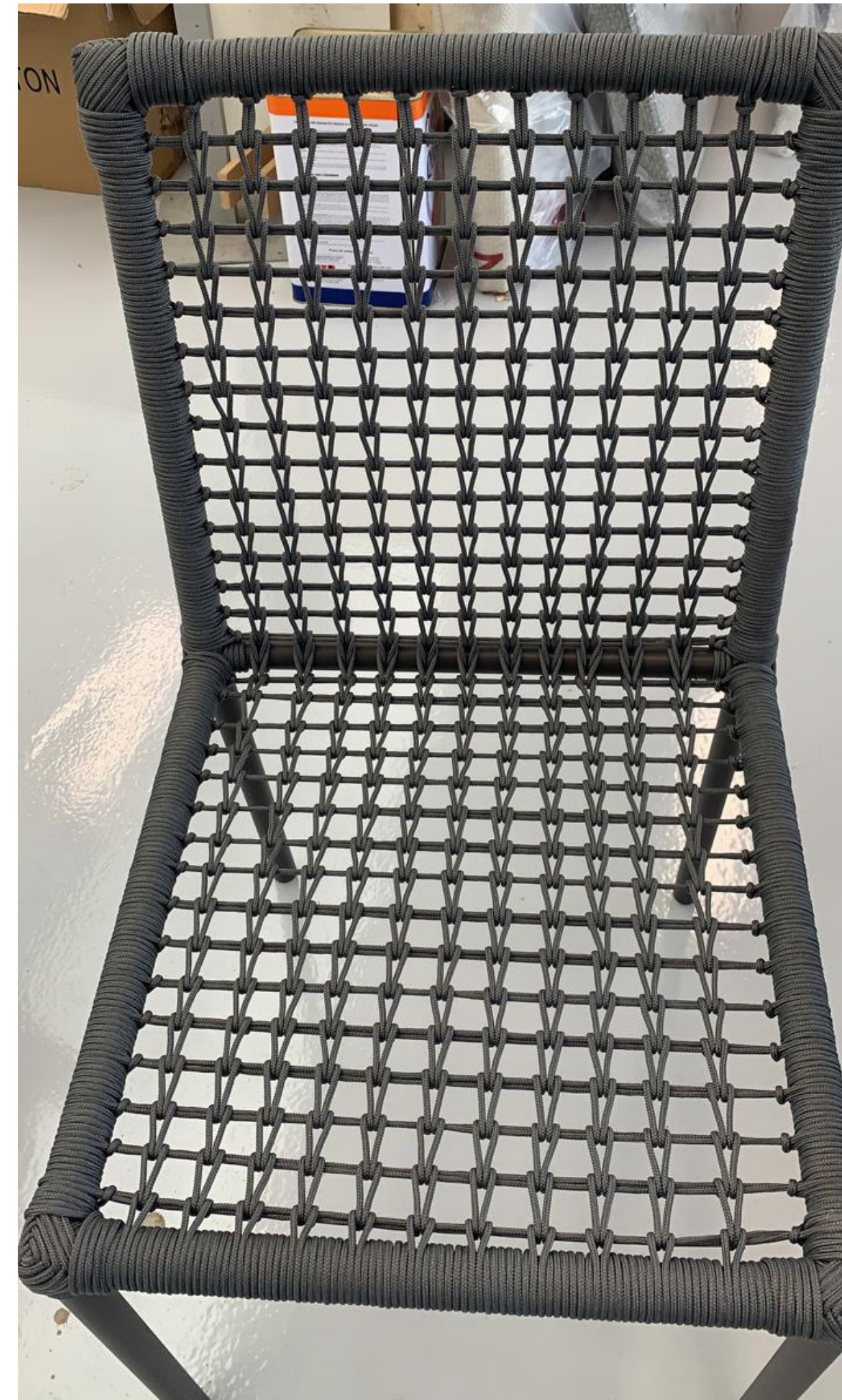

BRETON

CADEIRA MIRAFLORES

COLEÇÃO PERU

MATERIAL

Estrutura em madeira.
Encosto em palha.
Revestimento em maraú.

DIMENSÕES

Largura: 46cm sem braço/54cm com braço
Profundidade: 55cm
Altura: 83cm



BRETON

CADEIRA **BISPO**

COLEÇÃO ALEMANHA



DESIGNER
REINALDO
LOURENÇO

MATERIAL

Estrutura e pés em madeira maciça.
Revestimento em tecido ou couro.

DIMENSÕES

Largura: 60cm
Profundidade: 63cm
Altura: 84cm



CADEIRA **FAB**

COLEÇÃO **CROÁCIA**



DESIGNER
ESTEVÃO
TOLEDO

MATERIAL

Estrutura em madeira jequitibá rosa.
Tecido conforme mostruário.

DIMENSÕES

Largura: 67cm
Profundidade: 61cm
Altura: 77cm



BRETON

CADEIRA GIS

COLEÇÃO ALEMANHA



DESIGNER
ESTEVÃO
TOLEDO

MATERIAL

Estrutura e pés em madeira maciça.
Revestimento em tecido ou couro.

DIMENSÕES

Largura: 47cm
Profundidade: 57cm
Altura: 85cm



RRETON

CADEIRA VÉRTICE

COLEÇÃO CANÁDA



DESIGNER
CAROL GAY

MATERIAL

Estrutura em inox polido
ou jasper.

DIMENSÕES

Cadeira braço 6cm - 67 X 64 X 75cm

Poltrona braço 8cm - 81 X 64 X 75cm

Sofanete braço 8cm - 143 X 64 X 75cm



BRETON



CADEIRA **KEEL**

COLEÇÃO **ALEMANHA**



DESIGNER
ACIOLE FELIX

MATERIAL
Estrutura e pés em madeira maciça.
Revestimento em tecido ou couro.

DIMENSÕES
Largura: 48cm
Profundidade: 52cm
Altura: 82cm



BRETON

CADEIRA PISCO

COLEÇÃO PERU



DESIGNER
Luisa Moysés

MATERIAL

DIMENSÕES

Largura:
Profundidade:
Altura:

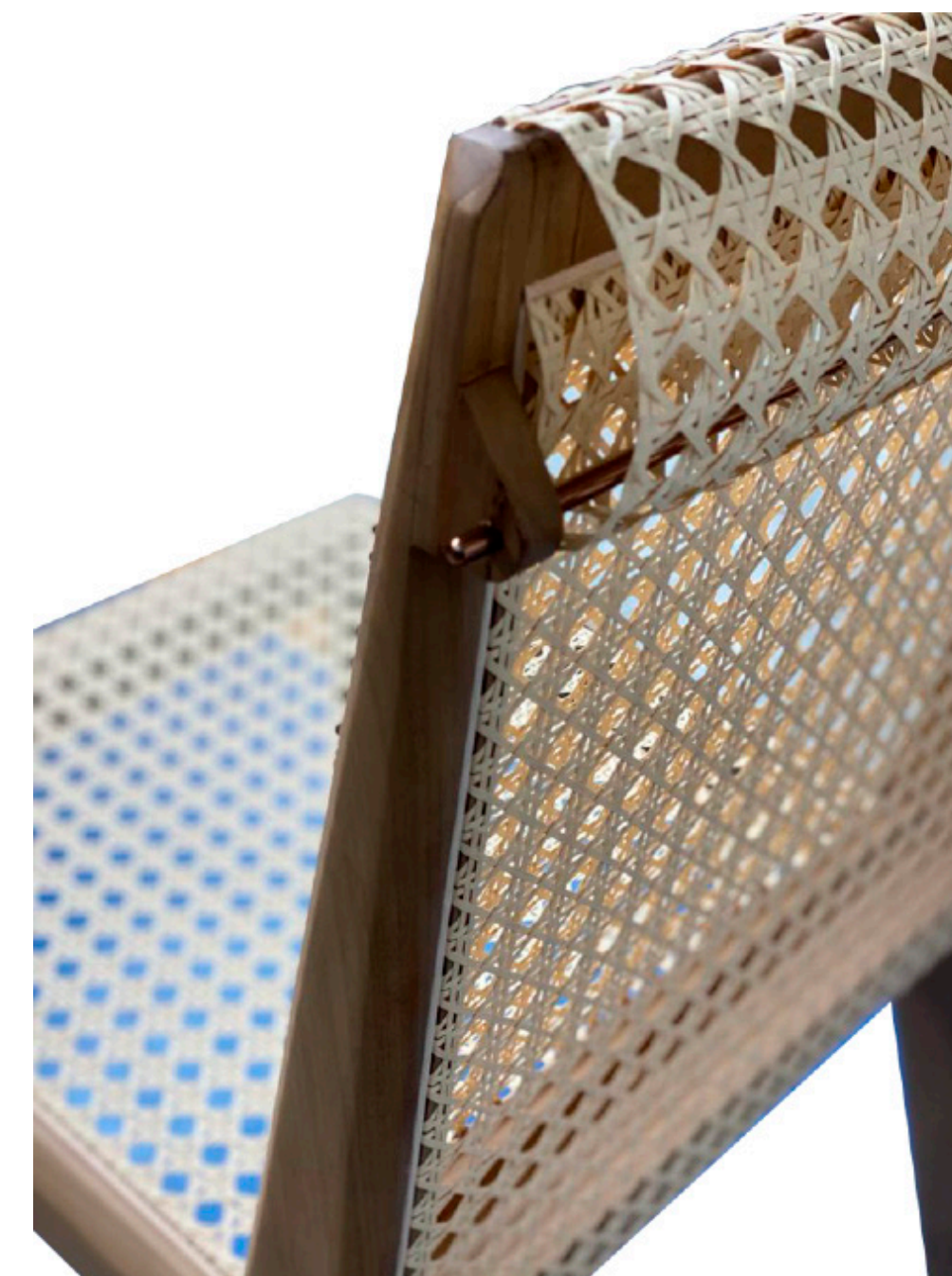

BRETON

CADEIRA NORTE

COLEÇÃO URUGUAI



DESIGNER

Luisa Moysés

MATERIAL

Estrutura em madeira tauari, junções de espiga, com maior resistência. Assento e encosto independentes em tecido ou soleta, com travamento em madeira tauari. Acabamento em verniz PU.

DIMENSÕES

Largura: 58cm
Profundidade: 67cm
Altura: 86cm



BRETON

CADEIRA LE MANS

COLEÇÃO ALEMANHA

BRETON



MATERIAL

Estrutura em madeira maciça e compensado.
Pé em madeira maciça com ponteira de alumínio.
Revestimento em tecido ou couro.

DIMENSÕES

Largura: 50cm
Profundidade: 57cm
Altura: 85cm

CADEIRA **STUTGART**

COLEÇÃO ALEMANHA



MATERIAL

Estrutura em madeira maciça e compensado.
Pés em madeira maciça com ponteira de alumínio.
Revestimento em tecido ou couro.

DIMENSÕES

Largura: 52cm
Profundidade: 60cm
Altura: 81cm



CADEIRA **MOET**

COLEÇÃO FRANÇA

MATERIAL

Estrutura em madeira pinus de reflorestamento, base em aço carbono pintado ou banho metálico, assento com espuma densidade 26.

DIMENSÕES

Largura:70cm
Profundidade:65cm
Altura:75cm



BRETON

CADEIRA PETRA

COLEÇÃO JORDÂNIA

MATERIAL

Estrutura em alumínio, pintura epóxi preto, trama em junco lxl cor castanho, pés giratório em madeira cor castanho.

DIMENSÕES

Largura:77cm
Profundidade:64cm
Altura:84cm



BRETON

CADEIRA BRUXELAS

COLEÇÃO BÉLGICA

MATERIAL

Concha em multilaminado de madeira
Estrutura em aço maciço pintado

DIMENSÕES

Largura: 60cm
Profundidade: 57cm
Altura: 72cm



BRETON

CADEIRA **AIMI**

COLEÇÃO JAPÃO

MATERIAL

Pés em madeira ou madeira laqueada,
Assento em tecidos fornecidos.

DIMENSÕES

Largura: 51cm
Profundidade: 67cm
Altura: 48cm



BRETON

CADEIRA **AZUMI**

COLEÇÃO JAPÃO

MATERIAL

Pés em madeira ou madeira laqueada,
Assento em tecidos fornecidos.

DIMENSÕES

Largura: 64cm
Profundidade: 65cm
Altura: 88cm



BRETON

CADEIRA **MIKA**

COLEÇÃO JAPÃO

MATERIAL

Pés em madeira ou madeira laqueada,
Assento em tecidos fornecidos.

DIMENSÕES

Largura: 56cm
Profundidade: 64,5cm
Altura: 89cm



BRETON

CADEIRA **AIKA**

COLEÇÃO JAPÃO

MATERIAL

Pés em madeira tingida ou laqueada,
assento em tecidos fornecidos e
palha fina ou sextavada.

DIMENSÕES

Largura: 61 ou 57cm
Profundidade: 90cm
Altura: 90cm

BRETON



CADEIRA **BERENICE**

COLEÇÃO EGITO

MATERIAL

Estrutura em tubo de aço carbono galvanizado com pintura eletrostática.
Revestimento tramado em corda náutica.

DIMENSÕES

Largura:70cm
Profundidade:52cm
Altura:80cm



BRETON

CADEIRA NILO

COLEÇÃO EGITO

MATERIAL

Estrutura em tubo de aço carbono galvanizado com pintura eletrostática.
Revestimento tramado em corda náutica.

DIMENSÕES

Largura:70cm
Profundidade:54cm
Altura:89cm



BRETON

CADEIRA PORÃ

COLEÇÃO **CARIBE**

MATERIAL

Al: Champagne Micro Corda Areia Mesclada
Tecido Solares Fendi

DIMENSÕES

Largura: 57cm
Profundidade: 60cm
Altura: 80cm



BRETON

CADEIRA **JOLY**

COLEÇÃO **CARIBE**

BRETON



MATERIAL

Al: Preto Corda Preta e Corda Mesclada

DIMENSÕES

Largura: 45cm
Profundidade: 45cm
Altura: 89cm

BANCOS

PRODUTOS
2021

BANCO MINATO

COLEÇÃO JAPÃO



MATERIAL

Pés em madeira ou laca
Assento em tecido e tiras
em courissimo.

DIMENSÕES

Largura: 180cm
Profundidade: 45cm
Altura: 43cm

BANCO LEBLON

COLEÇÃO BRASIL



DESIGNER

Diogo Giácomo

MATERIAL

DIMENSÕES

Largura:
Profundidade:
Altura:

BRETON



BANCO ALBERT

COLEÇÃO PERU



DESIGNER
RAFAEL
PRETO

MATERIAL

Estrutura em madeira ou laca conforme mostruário.
Palha GLX ou miele.

DIMENSÕES

Largura:184cm
Profundidade:54cm
Altura:80cm

BRETON

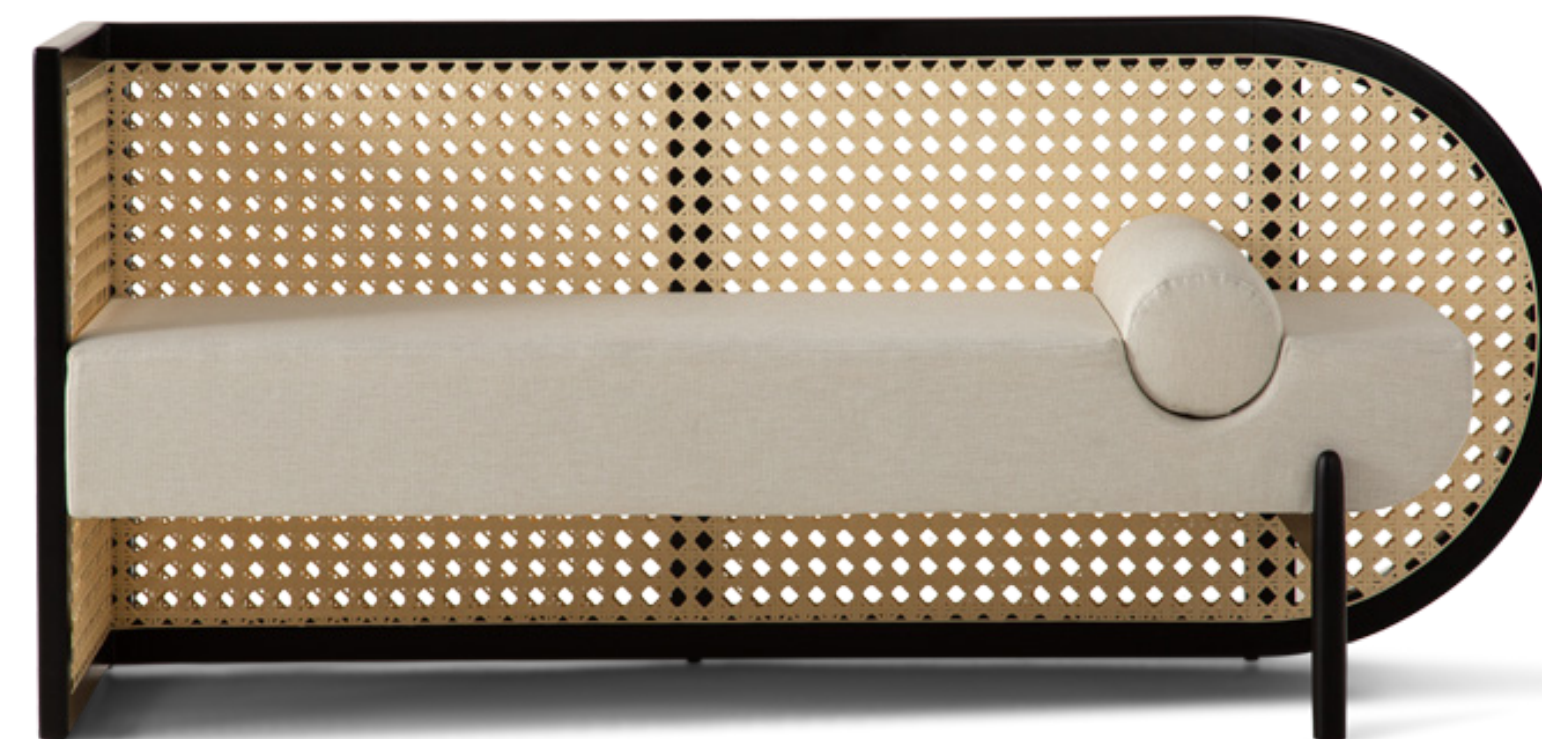

BANCO NOAH

COLEÇÃO CANADÁ



DESIGNER
RAFAEL
PRETO

MATERIAL

ASSENTO COURO LA PAZ PRETO
BAÚ EM CARVALHO EBANIZADO
TAMPO EM PALHA PRETA E DETALHES
EM LATÃO

DIMENSÕES

LARGURA: 245CM
PROFUNDIDADE: 45CM
ALTURA: 40CM

BRETON



BANCO BARACOA

COLEÇÃO CUBA



DESIGNER

GRACIA
MENDES

MATERIAL

BASE : TAUARÍ MACIÇO
ESTOFADO : FOUTON
ACABAMENTO : FREIJÓ, NOGUEIRA

DIMENSÕES

LARGURA: 120 ATÉ 200CM
PROFUNDIDADE: 60CM
ALTURA: 35CM



BANCO BOA VISTA

COLEÇÃO BRASIL

BRETON



DESIGNER
Luisa Moysés

MATERIAL

DIMENSÕES
Largura:
Profundidade:
Altura:



CHAISES

PRODUTOS
2021

CHAISE CELLO

COLEÇÃO PORTUGAL



DESIGNER

Lilly e Renat

MATERIAL

Assento fixo, com costura debrum
compose.
Pés de madeira em verniz ou laca.

DIMENSÕES

Profundidade: 100cm
Altura: 45cm

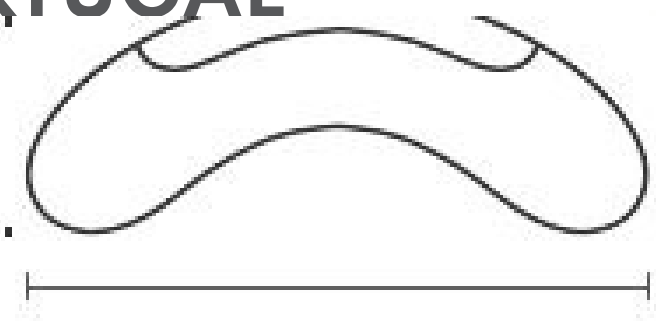

SB 2BI

1,80 x 1,00
2,00 x 1,00 m
2,20 x 1,00 m
2,40 x 1,15 m
2,60 x 1,15 m
2,80 x 1,15 m
3,00 x 1,20 m

Módulos SB 2BI

180 X 100cm
200 X 100cm
220 X 100cm
240 X 115cm
260 X 115cm
280 X 115cm
300 X 120cm



BRETON

CHAISE ALBERT

COLEÇÃO PERU



DESIGNER
RAFAEL
PRETO

MATERIAL

Acabamentos em madeira ou laca.
Palha GLX ou miele.

DIMENSÕES

Largura:165/185cm
Profundidade:165/185cm
Altura:80cm

BRETON



CHAISE VERUS

COLEÇÃO COSTA RICA



DESIGNER
REINALDO
LOURENÇO

MATERIAL

Estrutura em aço carbono
com pintura preta
Estofado corano preto

DIMENSÕES

Largura: 1,78CM
Altura: 78CM
Profundidade:
46CM

BRETON



CHAISE **SAN MORITZ**

COLEÇÃO ALEMANHA

MATERIAL

Estrutura em madeira maciça.
Revestimento conforme mostruário.
Almofadas em fibra siliconizada.
Base em madeira maciça recuado.

DIMENSÕES

Largura:165cm
Profundidade:165cm
Altura:40cm

BRETON



CHAISE SU

COLEÇÃO IRLANDA



DESIGNER
RAFAEL
SIMÕES

MATERIAL

ESTRUTURA: COMPENSADO MULTILAMINADO
FIXAÇÃO DA ESTOFARIA EM AÇO INOX
PERCINTAS EM COURO SOLETTAL 32 LINHAS
ACABAMENTO: LAMINADO DE MADEIRA NATURAL
ESTÓFADO EM COURO NATURAL, SINTÉTICO OU
TECIDO

DIMENSÕES

LARGURA: 1950MM
PROFUNDIDADE: 710MM
ALTURA: 780MM

BRETON

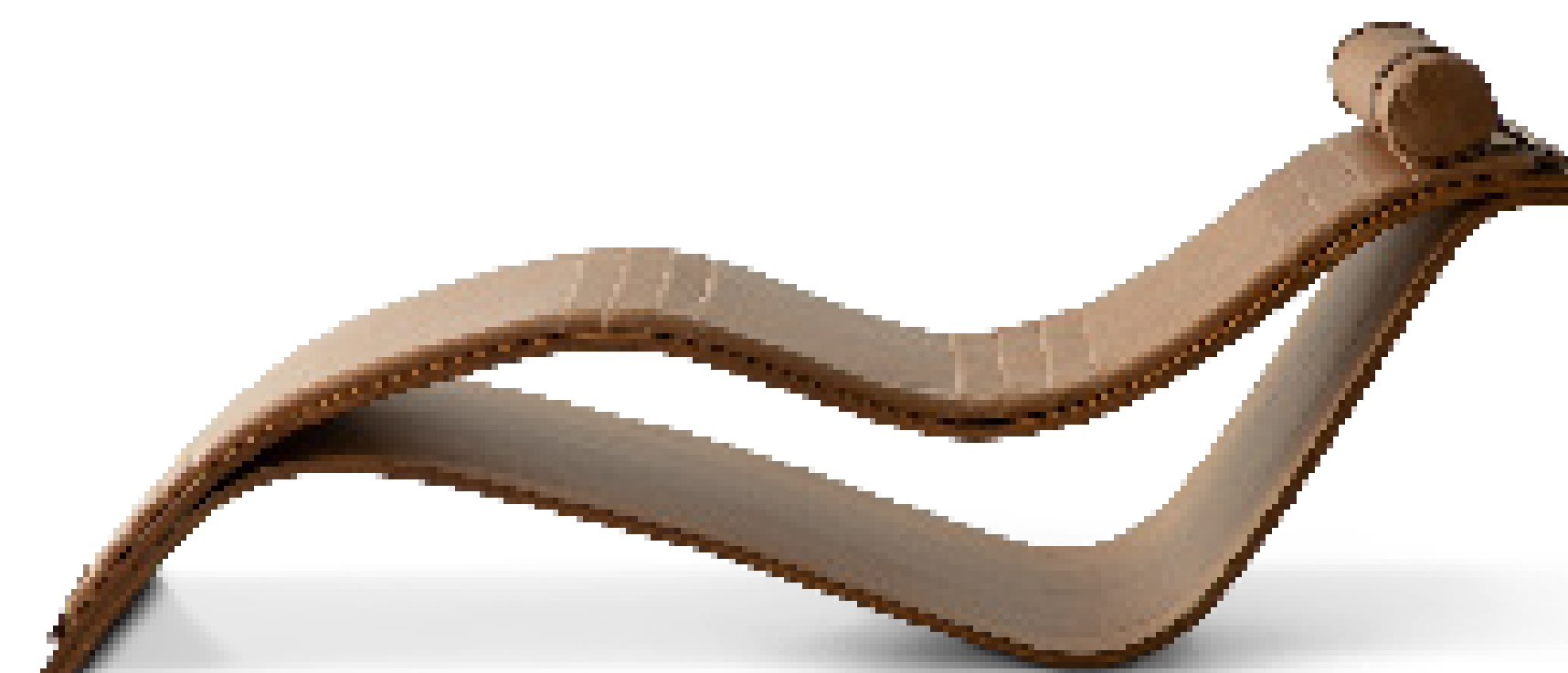

ESPREGUIÇADEIRAS

PRODUTOS
2021

ESPREGUIÇADEIRA MADALENA

COLEÇÃO BRASIL



DESIGNER
PEDRO
MENDES

MATERIAL

DIMENSÕES

Largura:
Profundidade:
Altura:

BRETON

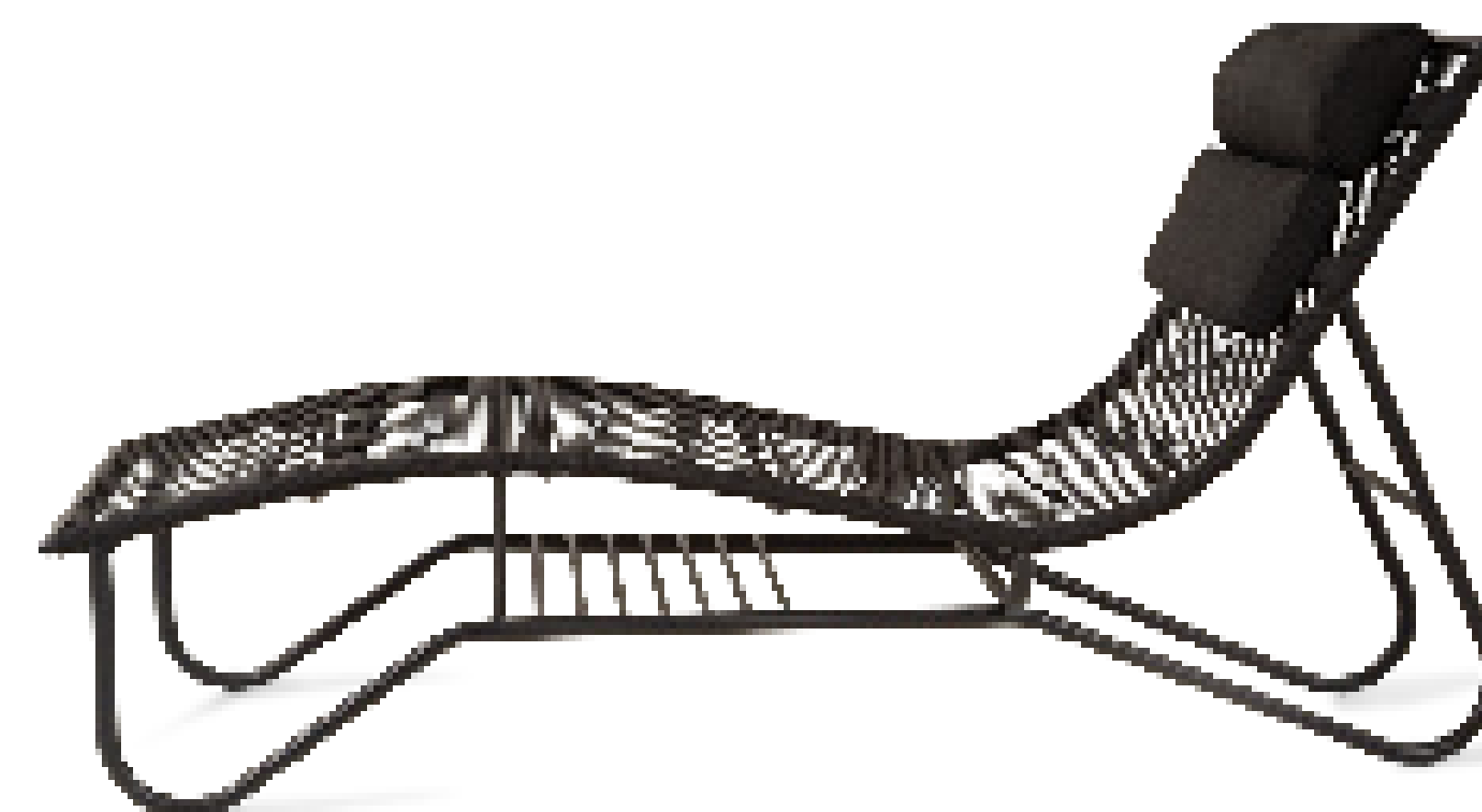

ESPREGUIÇADEIRA **DALMO**

COLEÇÃO BRASIL



DESIGNER
PEDRO
MENDES

MATERIAL

DIMENSÕES

Largura:
Profundidade:
Altura:

BRETON



ESPREGUIÇADEIRA PORÃ

COLEÇÃO **CARIBE**

MATERIAL

Al: Champagne Micro Corda Areia Mesclada
Tecido Solares Fendi

DIMENSÕES

Largura: 208cm
Profundidade: 80cm
Altura: 36cm



BRETON

PUFFS

PRODUTOS
2021

PUFF GALEGA

COLEÇÃO BRASIL

DESIGNER
ANDRÉ
GRIPPI

MATERIAL

DIMENSÕES

Largura:
Profundidade:
Altura:

BRETON



PUFF KENOA

COLEÇÃO BRASIL



DESIGNER

Luisa Moysés

MATERIAL

DIMENSÕES

Largura:
Profundidade:
Altura:

BRETÓN

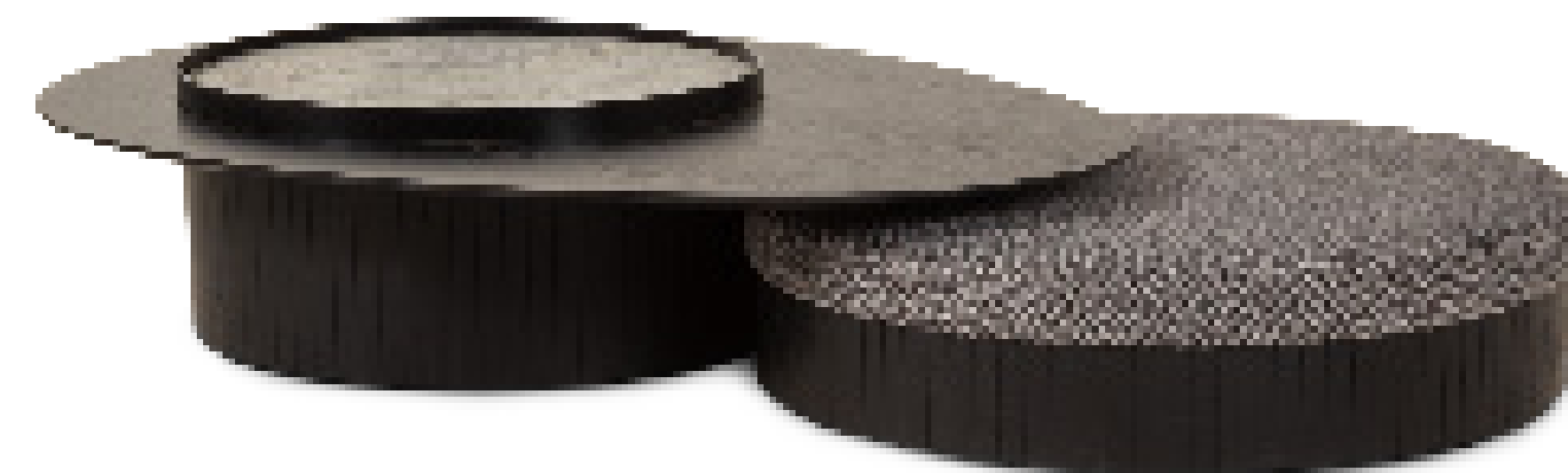

PUFF PRETZEL

COLEÇÃO ALEMANHA

BRETON



MATERIAL

Estrutura em madeira maciça.
Revestimento conforme mostruário.

DIMENSÕES

Largura: 75/85/95/105/115 cm
Altura: 33 cm



PUFF ATHOS

COLEÇÃO NOLAN



DESIGNER

Eminência
em Preto

MATERIAL

Assento em multilaminado de madeira,
totalmente estofada
Base em Aço Carbono Pintado

DIMENSÕES

Largura: 57cm
Profundidade: 40cm
Altura: 40cm

BRETON



PUFF LION

COLEÇÃO FRANÇA

BRETON



MATERIAL

Estrutura em madeira pinus dere florestamento, base em aço carbono pintado ou banho metálico, assento com espuma densidade 26.

DIMENSÕES

Largura:180cm
Profundidade:71cm
Altura:43cm

PUFF DIJON

COLEÇÃO FRANÇA

BRETON



MATERIAL

DIMENSÕES

SOFÁS

PRODUTOS
2021

SOFÁ SEVILLA

COLEÇÃO ESPANHA



MATERIAL

DIMENSÕES

Módulo 5 assentos em L - 383 X 341 X 83cm/413 X 361 X 83cm/
443 X 381 X 83cm/473 X 401 X 83cm/503 X 421 X 83cm

Módulo 2 assentos - 184 X 171 X 83cm/204 X 171 X 83cm/
224 X 171 X 83cm/244 X 171 X 83cm/264 X 171 X 83cm

Módulo 3 assentos - 264 X 171 X 83cm/294 X 171 X 83cm/
294 X 171 X 83cm/324 X 171 X 83cm/254 X 171 X 83cm/
284 X 171 X 83cm/

BRETON



SOFÁ ÁVILA

COLEÇÃO ESPANHA



BRETON



MATERIAL

Estrutura em pinus,
compensado e MDF.
Tecido em poliéster,
plástico, linho
ou viscose

Módulo com 2 assentos e 2 braços - 200/210/220/230/240cm

Módulo com 2 assentos e 1 braço - 200/210/220/230/240cm

Módulo com 1 assento e Puff - 180/190/200/210/220cm

Módulo Recamier com estofado vazado e assento sem braço - 180/
190/200/210/220cm

SOFÁ MARBELA

COLEÇÃO ESPANHA



BRETON

MATERIAL

Estrutura em pinus, compensado e MDF.

Tecido em poliéster, plástico, linho ou viscose.

Pés em madeira.

Módulos com 1 braço - 95/105/115/125/135cm

Módulos sem braço - 80/90/100/110/120cm

Módulo com 2 assentos e 1 braço - 175/195/215/235/255cm

Módulo com 2 assentos e 2 braços - 190/210/230/250/270cm

Módulo Puff - 120cm

SOFÁ ESCALA

COLEÇÃO ARGENTINA

BRETON

MATERIAL

DIMENSÕES

Largura:
Profundidade:
Altura:



SOFÁ NAMOS

COLEÇÃO GRÉCIA

BRETON



MATERIAL

Estrutura em pinus.
Revestimento em tecido ou couro.
Almofadas em fibra siliconizada e manta.

DIMENSÕES

Módulo com 2 braços - 180 X 90 X 103cm/200 X 90 X 103cm/
220 X 90 X 103cm/240 X 90 X 103cm/260 X 90 X 103cm/
280 X 90 X 103cm/300 X 90 X 103cm/320 X 90 X 103cm

Módulo com 1 braço - 190 X 90 X 103cm/210 X 90 X 103cm/
230 X 90 X 103cm/250 X 90 X 103cm

Módulo canto - 103 X 90 X 103cm

Puff - 95 X 95cm



SOFÁ RHODES

COLEÇÃO GRÉCIA

MATERIAL

DIMENSÕES

Largura:
Profundidade:
Altura:

BRETON



SOFÁ BISPO

COLEÇÃO ALEMANHA



DESIGNER
REINALDO
LOURENÇO

MATERIAL

Estrutura em madeira maciça.
Revestimento conforme mostruário.
Bandeja em MDF cinamomo
Base em MDF cinamomo.

BRETON



Modulos sem braços

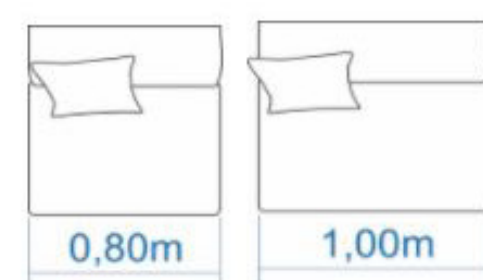

Modulos com braços

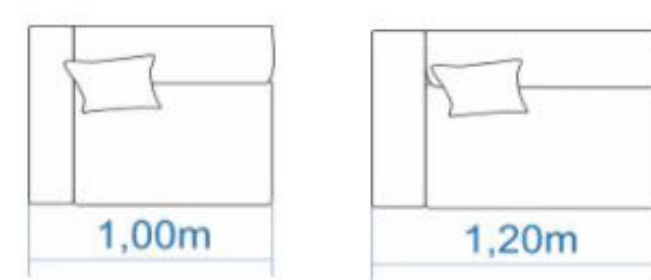

Nicho lateral



Puffs

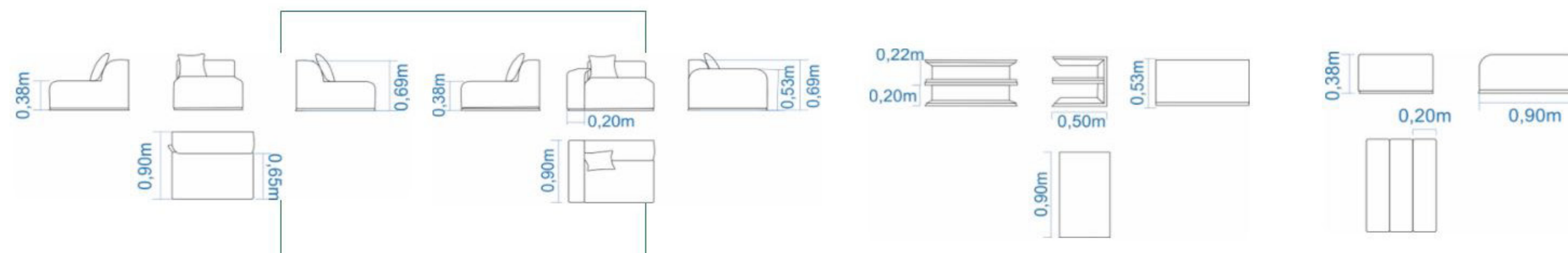
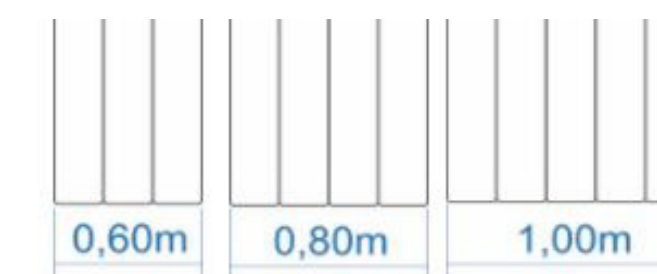

SOFÁ TERRACE

COLEÇÃO BRASIL

BRETON



MATERIAL

DIMENSÕES

Largura:
Profundidade:
Altura:

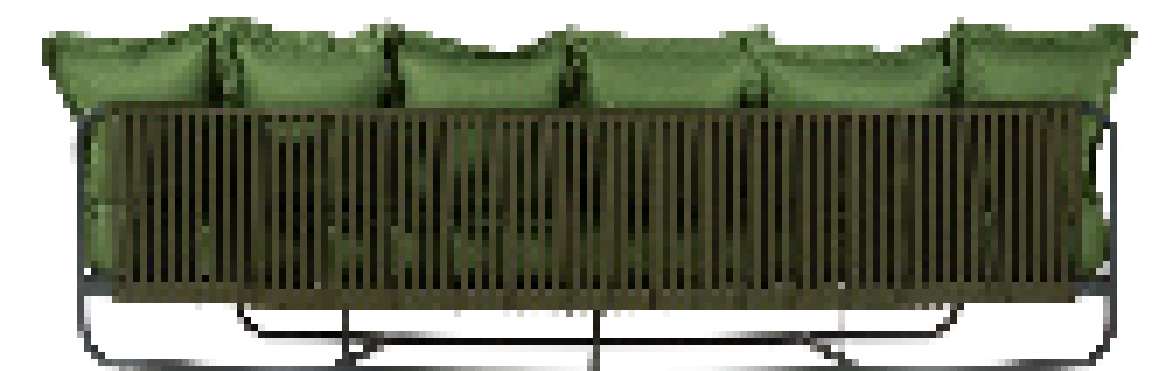
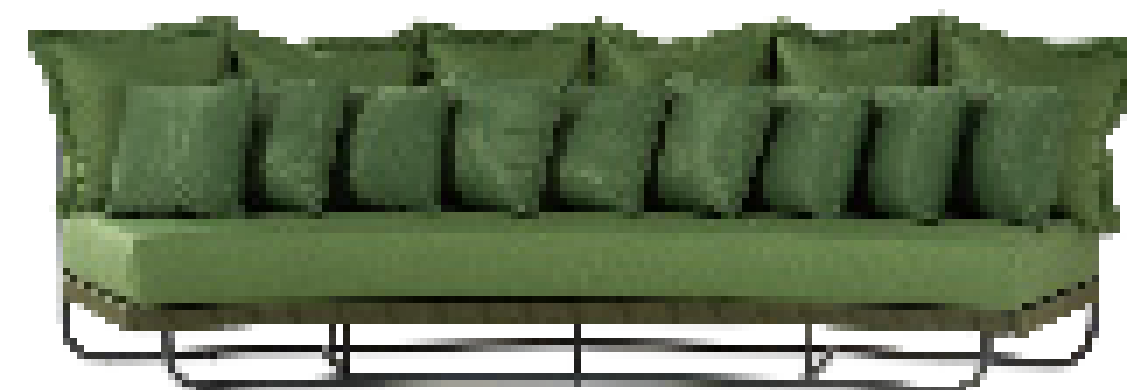

SOFÁ AGOGO

COLEÇÃO PORTUGAL



DESIGNER

Lilly e Renata Sarti

MATERIAL

Assento fixo sem detalhe de costura.
Encosto e braços fixos costurados em gomos.
Pé em plástico na cor preta

DIMENSÕES

Largura: 180/200/220/240/260/280/300cm
Profundidade: 120cm
Altura: 45cm



SOFÁ LINDEN

COLEÇÃO ALEMANHA

BRETON



Modulos sem braços

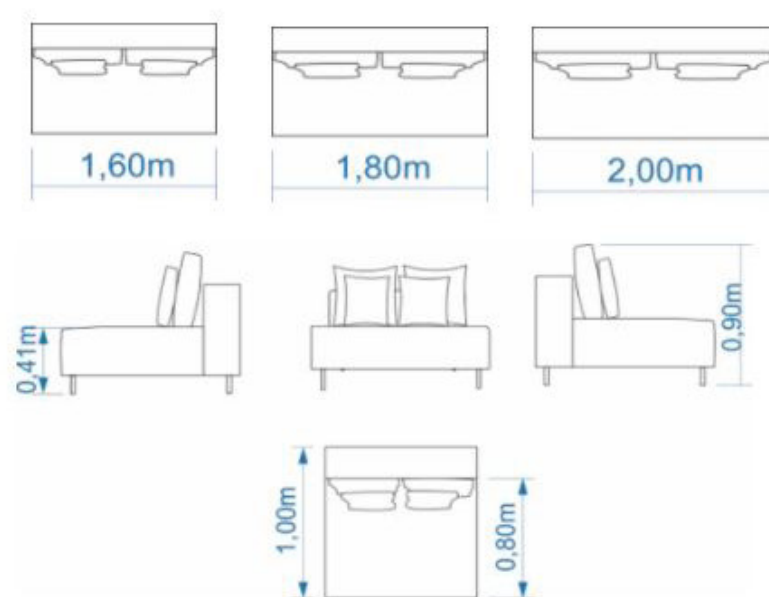

Modulos com braços esq/dir

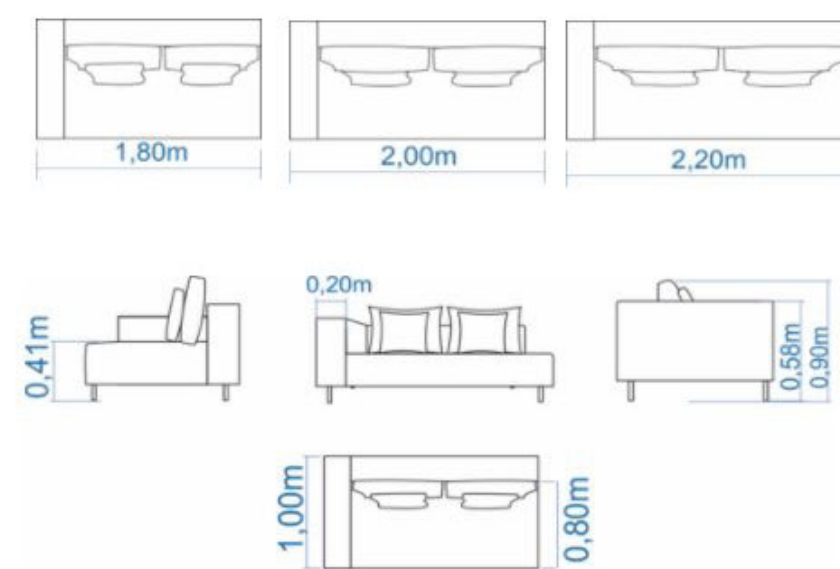

Modulos canto extendido esq/dir

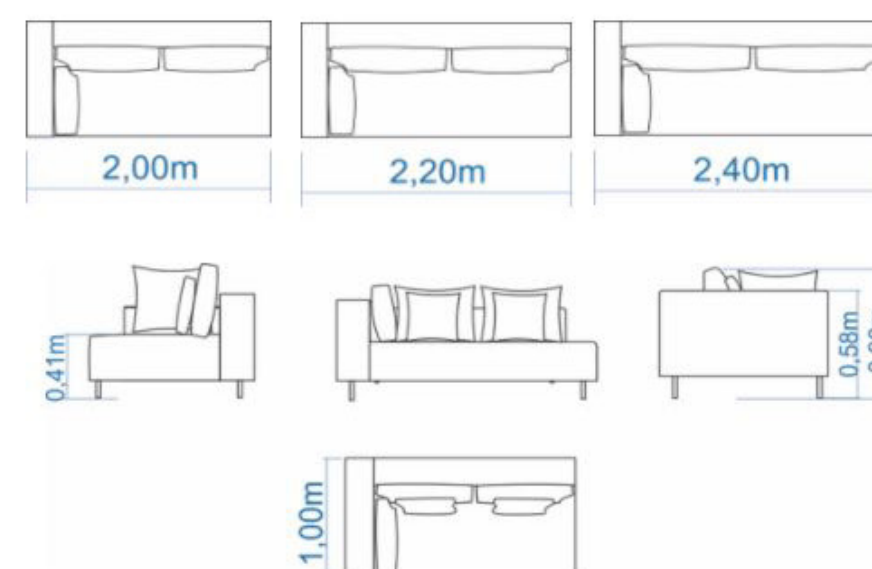

MODULOS SEM BRAÇOS COM
BANDEJA+USB ESQ/DIR

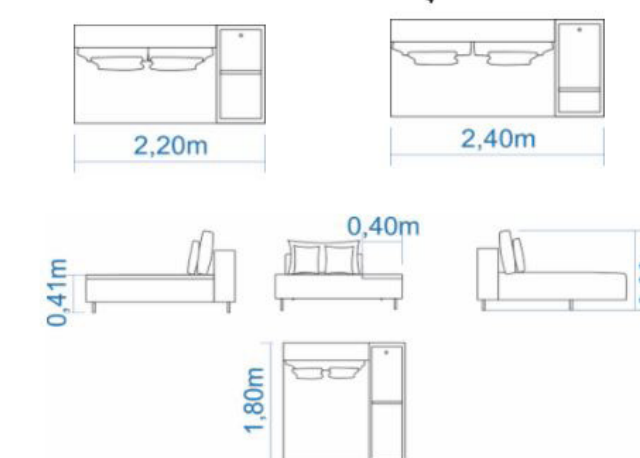

MODULOS CANTO EXTENDIDO + PUFF TERMINAL ESQ/DIR

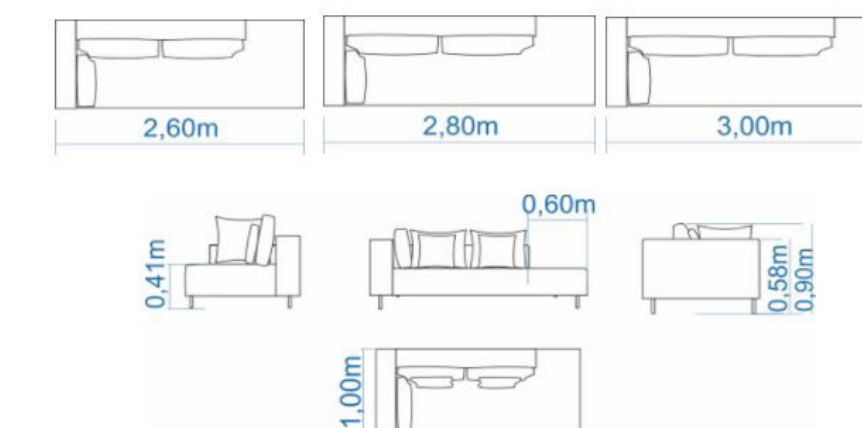

MATERIAL

Estrutura em madeira maciça.
Revestimento conforme mostruário.
Almofadas forradas com fibra silicona
envolvidas com manta.
Base em aço carbono pintado.
Bandeja laminada.

CHAISE SEM BRAÇOS

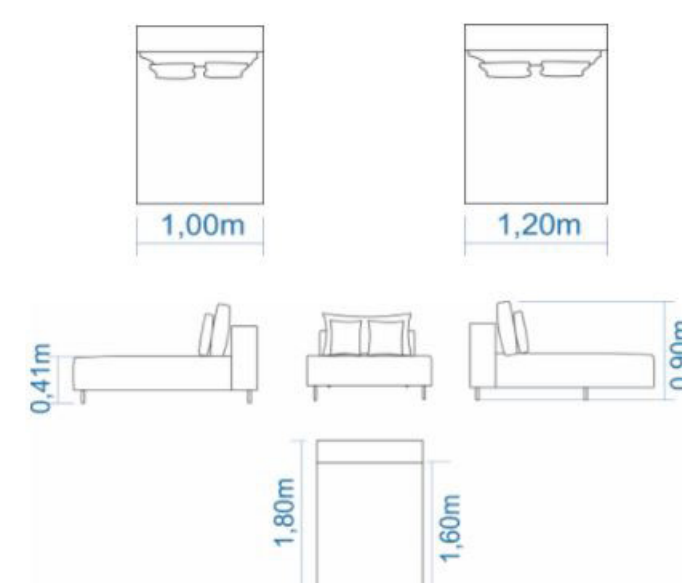

CHAISE COM BRAÇOS ESQ/DIR

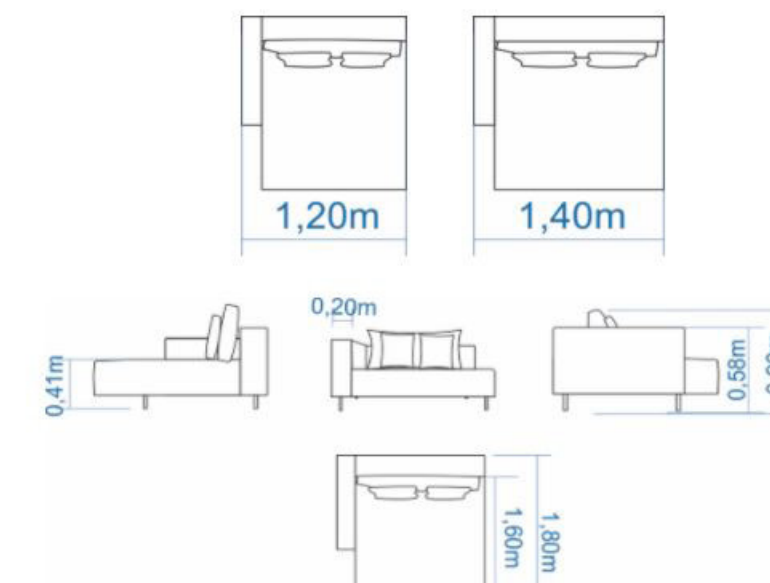

CHAISE SEM BRAÇOS COM BANDEJA + USB ESQ/DIR

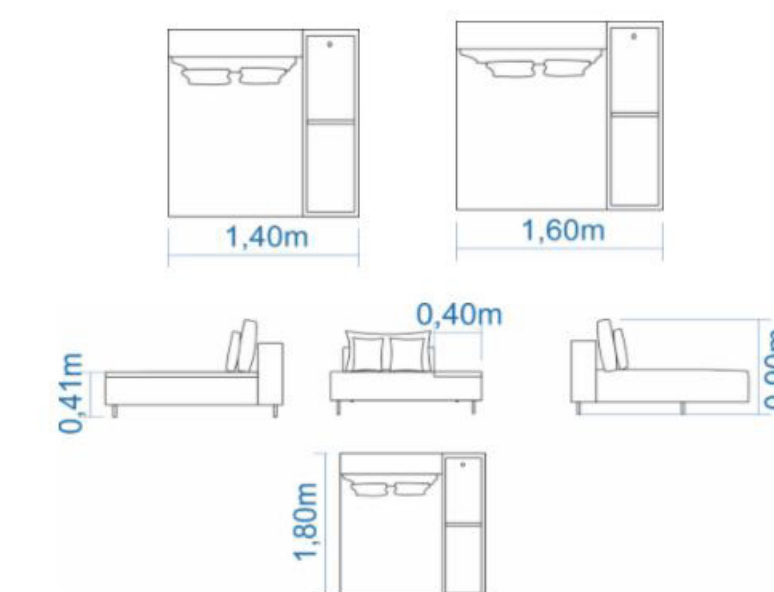

SOFÁ BADEN

COLEÇÃO ALEMANHA



BRETON



MATERIAL

Estrutura e pés em madeira maciça.
Revestimento conforme mostruário.
Almofadas forradas com fibra silicona
envolvidas com manta.

Modulos sem braços

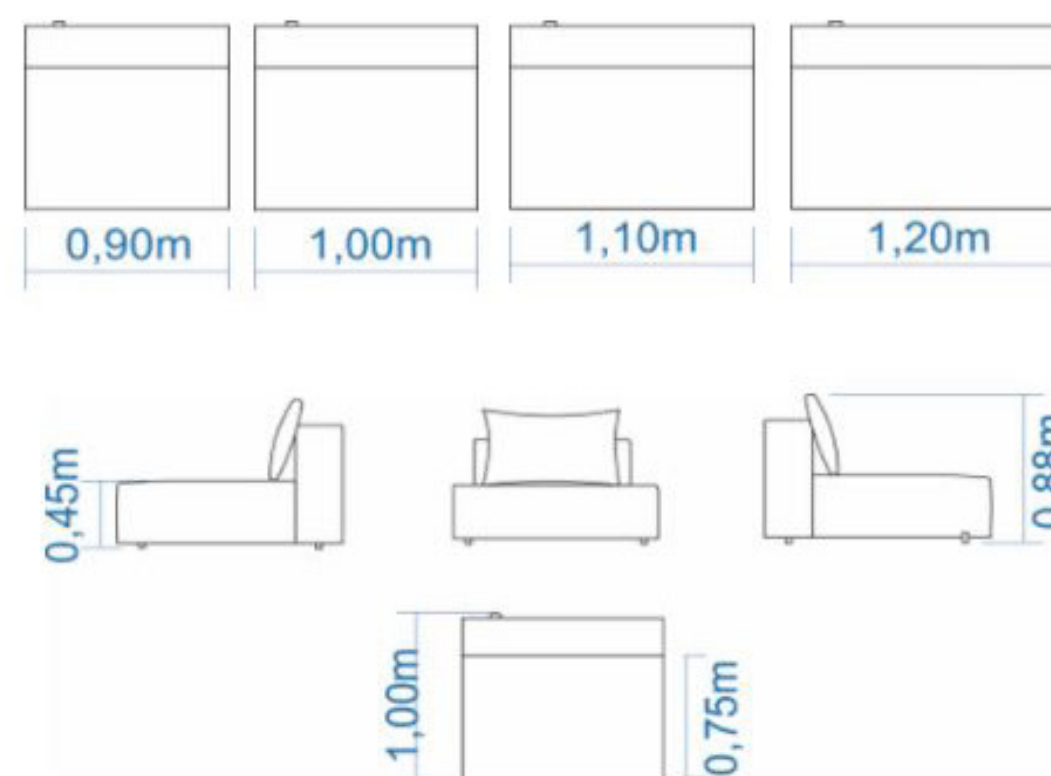

Modulos com braços esq/dir

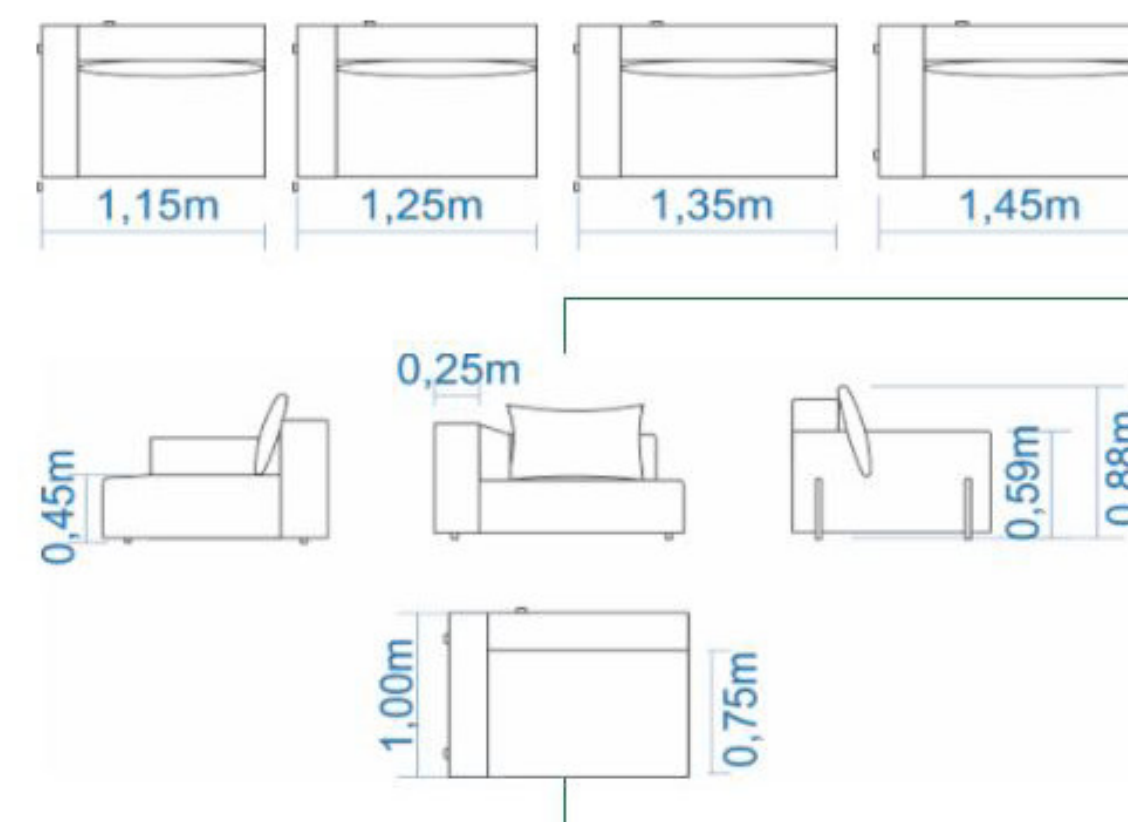

Chaise com braços esq/dir

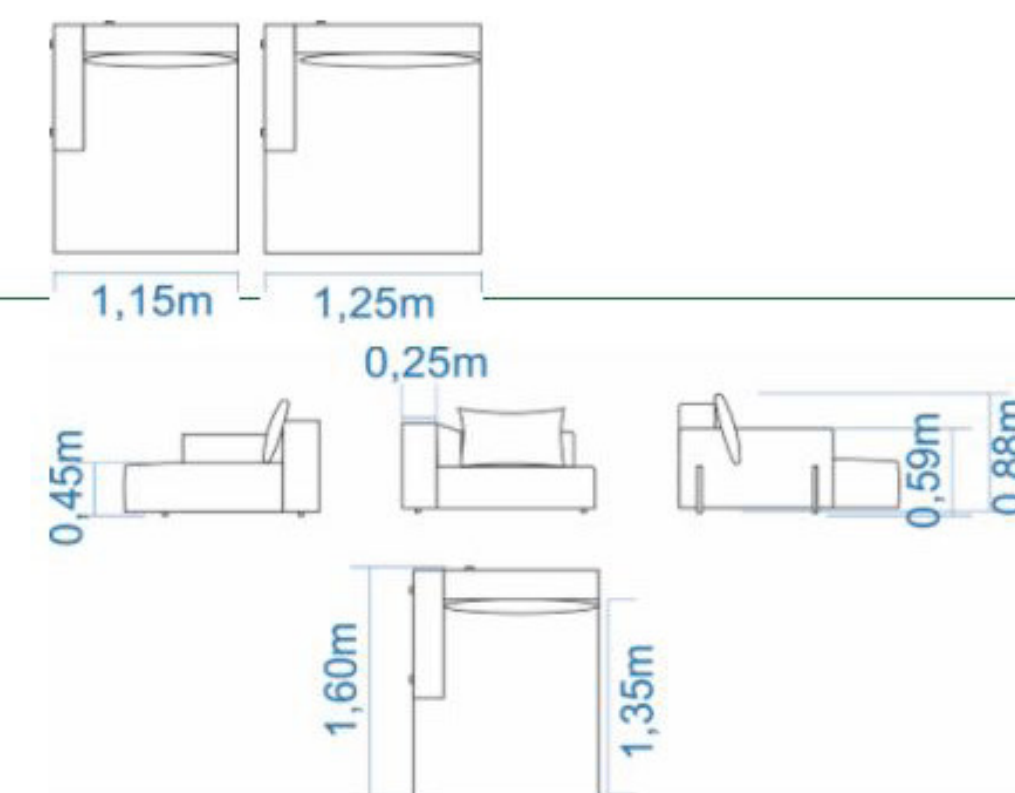

SOFÁ DALLAS

COLEÇÃO ESTADOS UNIDOS

MATERIAL

Estrutura em pinus, duratex,
manta acrílica e espuma D28.
Almofadas em TNT, espuma D30
e fibra poliéster siliconizada.
Base em aço carbono laminado.

DIMENSÕES

Módulo 2B - 300 X 100 X 82cm/280 X 100 X 82cm/
260 X 100 X 82cm/240 X 100 X 82cm/220 X 100 X 82cm/
200 X 100 X 82cm

Módulo 1B - 280 X 100 X 82cm/260 X 100 X 82cm/
240 X 100 X 82cm/220 X 100 X 82cm/200 X 100 X 82cm/
180 X 100 X 82cm

Chaise - 120 X 150 X 82cm

CTO - 100 X 100 X 82cm

Puff - 100 X 60 X 45cm



BRETON

SOFÁ SAN DIEGO

COLEÇÃO ESTADOS UNIDOS

BRETON



MATERIAL

Estrutura em aço carbono e compensado.
Encosto e assento em TNT, espuma D30,
manta acrílica e fibra poliéster siliconizada.
Base em aço carbono.

DIMENSÕES

Largura: 200/220/240/260/280/300cm
Profundidade: 85cm
Altura: 42cm até o assento

SOFÁ SÃO FRANCISCO

COLEÇÃO ESTADOS UNIDOS

BRETON



MATERIAL

Estrutura em pinus, duratex e manta acrílica.
Encosto e assento em espuma D30, TNT e
fibras poliéster siliconizada.
Base em aço carbono.

DIMENSÕES

Módulo 1B - 115 X 110 X 85cm/125 X 110 X 85cm/
135 X 110 X 85cm/145 X 110 X 85cm/155 X 110 X 85cm

Módulo SB - 90 X 110 X 85cm/100 X 110 X 85cm/
110 X 110 X 85cm/120 X 110 X 85cm/130 X 110 X 85CM

SOFÁ FARO

COLEÇÃO PORTUGAL

DESIGNER

DANILO
LOPES

MATERIAL

Estrutura em eucalipto.
Revestimento conforme mostruário.
Pés em polipropileno injetado
na cor preto.



2B - 180/200/220/240/260/280/300cm

1B - 100/110/120/130/140/150cm

SB - 90/100/110/120/130/140cm

CH 1B - 100/110/120/130/140cm X 160cm

SB BI - 140/150/160/170/180/190cm

CTO - 100 X 100cm

PUFF CTO - 90 X 90cm

PUFF - 100/120/130/140 X 60cm

1B CURVO - 210 X 145cm/230 X 150cm/250 X 155cm/
270 X 160cm/290 X 165cm/310 X 170cm

1B BI CURVO - 225 X 145cm/235 X 150cm/245 X 155cm/
255 X 160cm/265 X 165cm/275 X 170cm

SB CURVO - 225 X 130cm/245 X 133cm/265 X 136cm/
285 X 139cm/305 X 142cm/325 X 145cm

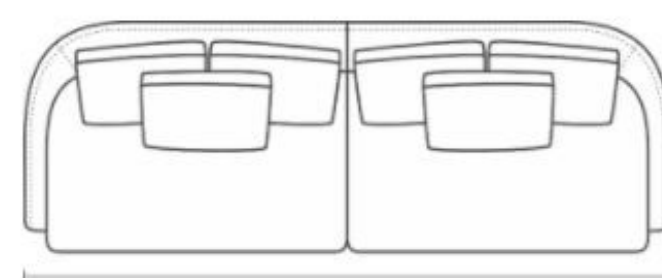

2B2

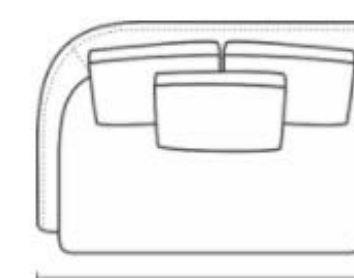

1B1

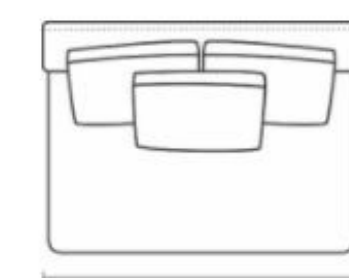

SB1

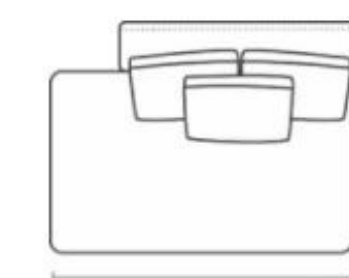

SBBI

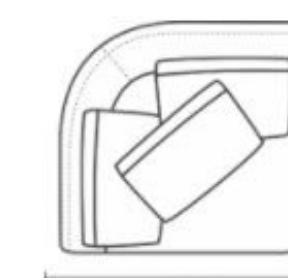

CTO

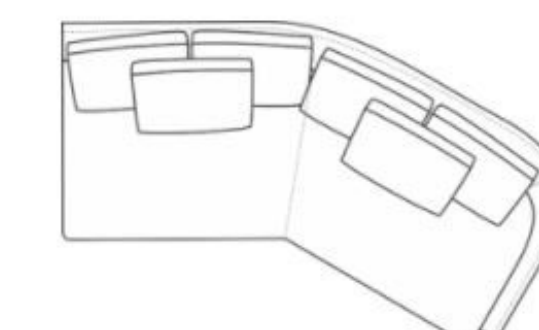

1B1 CURVO

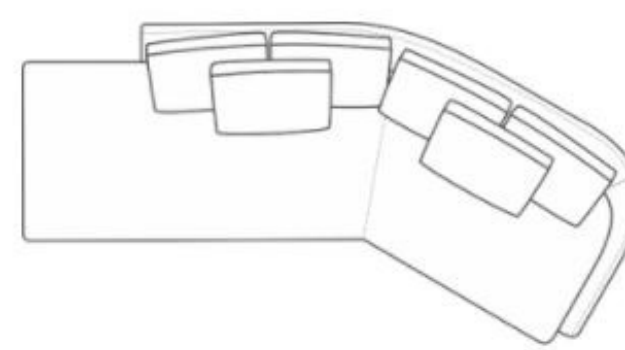

1BBI CURVO

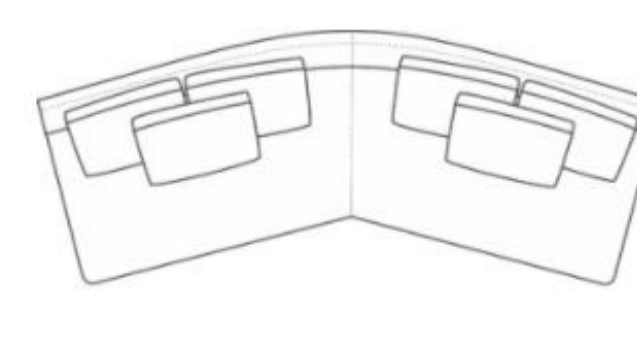

SB1 CURVO



PUFF CTO



PUFF

SOFÁ SANTA CLARA

COLEÇÃO CUBA



DESIGNER
GRACIA
MENDES

MATERIAL

ESTRUTURA : TAUARÍ MACIÇ
ESTOFADO : MOLAS BONNÉL
CAIXAS E BANDEJAS : FREIJÓ, NOGUEIRA

DIMENSÕES

LARGURA: 100 ATÉ 400CM
PROFUNDIDADE: 100CM
ALTURA: 60CM



SOFÁ **MIRAMAR**

COLEÇÃO **CUBA**



DESIGNER
PAULA
MÁXIMO

MATERIAL

ESTRUTURA : MADEIRA MACIÇA
BASE : AÇO CARBONO PINTADO
ESTOFADO : MOLAS BONNEL

DIMENSÕES

LARGURA: 80 ATÉ 300CM
PROFUNDIDADE: 90CM
ALTURA: 82CM



SOFÁ LUGO

COLEÇÃO **ESPANHA**

DESIGNER
DANILO
LOPES



MATERIAL

Estrutura em pinus, compensado e MDF.
Base em madeira caxeta laminada com pintura PU.
Mesa em MDF laminado com pintura PU.
Tecido em poliéster, plástico, algodão, viscose ou linho.

DIMENSÕES

Largura: 270/280/290/300cm
Profundidade: 105cm
Altura: 81cm

SOFÁ LUNAS

COLEÇÃO CARIBE

MATERIAL

Madeira Freijó, Tecido Copacabana
Café Cinza

DIMENSÕES

Largura:100cm
Profundidade:100cm
Altura:39cm

BRETON



APARADORES

PRODUTOS
2021

APARADOR **BOA VISTA**

COLEÇÃO BRASIL



DESIGNER
Luisa Moysés

MATERIAL

DIMENSÕES

Largura:
Profundidade:
Altura:

BRETON



APARADOR **HAVANA**

COLEÇÃO **CUBA**



DESIGNER
GRACIA
MENDES

MATERIAL

ESTRUTURA : TAUARÍ MACIÇO
TAMPO : RIPADO OU VIDRO
ACABAMENTO : FREIJÓ NATURAL

DIMENSÕES

LARGURA: 90 ATÉ 200CM
PROFUNDIDADE: 35CM
ALTURA: 40CM

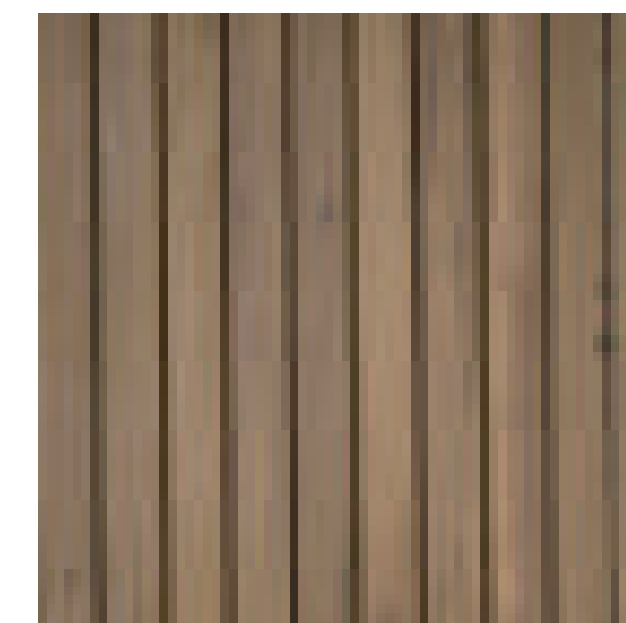

APARADOR RAINHA

COLEÇÃO CANADÁ



DESIGNER

Reinaldo Lourenço

MATERIAL

Estrutura em aço carbono pintado, aço carbono laminado, inox polido ou inox laminado.

DIMENSÕES

Largura: 150/170/190cm
Profundidade: 60cm
Altura: 78cm

BRETON



BRETON

APARADOR **ARCO**

COLEÇÃO ISRAEL



DESIGNER

FELIPE
PICCELLI

MATERIAL

ESTRUTURA : MDF
TAMPO : RECOURO
ACABAMENTO : RECOURO

DIMENSÕES

LARGURA: 180CM
PROFUNDIDADE: 55CM
ALTURA: 75CM



MESAS DE JANTAR

PRODUTOS
2021

MESA DE JANTAR **BOA VISTA**

COLEÇÃO BRASIL



DESIGNER

Luisa Moysés

MATERIAL

ESTRUTURA :
ACABAMENTO :

DIMENSÕES

LARGURA :
PROFUNDIDADE :
ALTURA :

BRETON

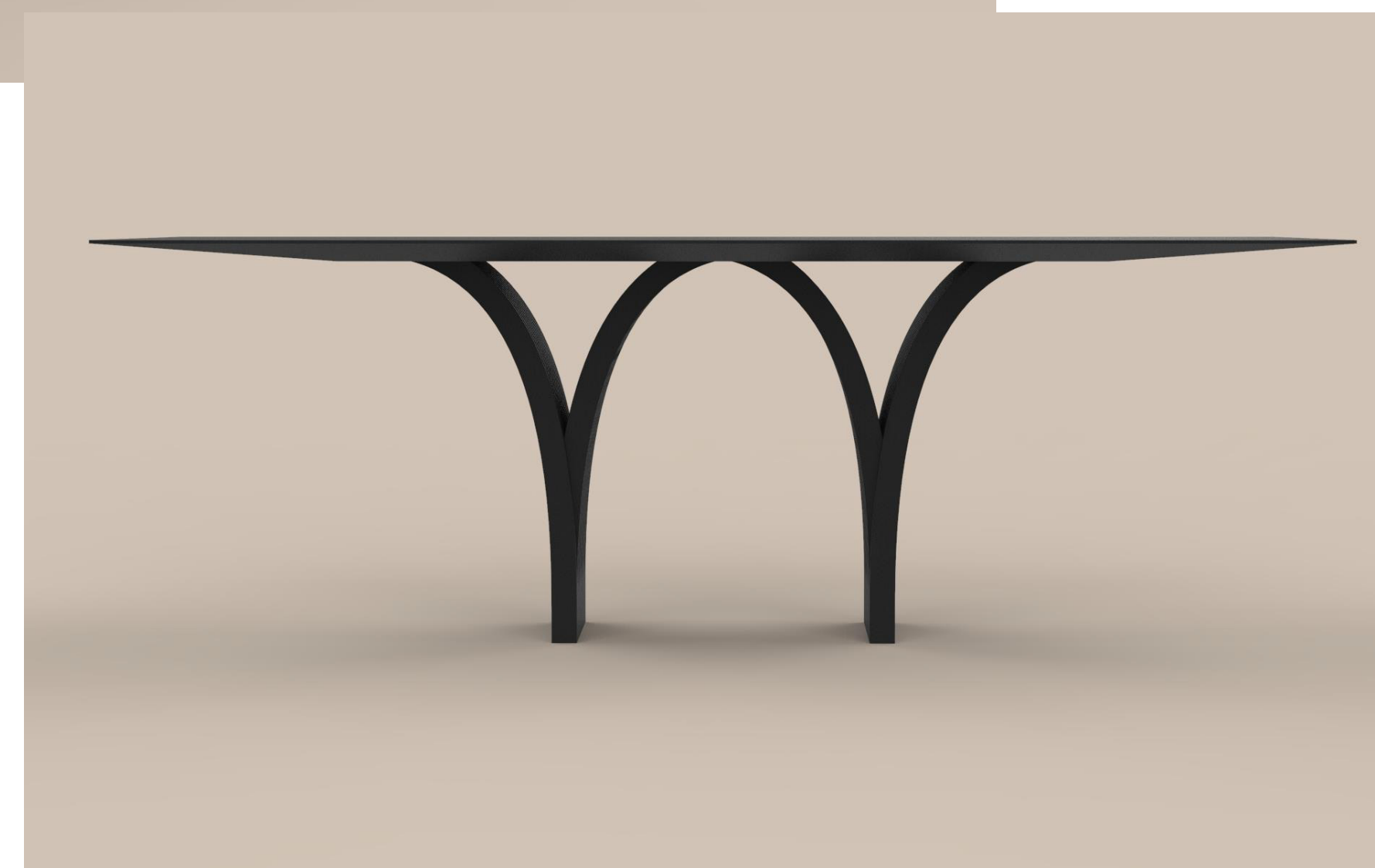

MESA DE JANTAR TAÍPE

COLEÇÃO BRASIL



DESIGNER

Luisa Moysés

MATERIAL
DIMENSÕES

Largura:
Profundidade:
Altura:

PRETON



MESA DE JANTAR **TIRAS**

COLEÇÃO **BRASIL**

DESIGNER

Fetice Design

MATERIAL

DIMENSÕES

Largura:
Profundidade:
Altura:

BRETON



MESA DE JANTAR

TEL AVIV

COLEÇÃO ISRAEL

BRETON

MATERIAL

Base de mdf revestido em couro,
laterais em couro, tampo revestido
em espelho ou vidro colorido,
bisotê do tampo em laminação facetada.

DIMENSÕES

Largura: 120 até 140cm
Profundidade: 120 até 140cm
Altura: 76cm

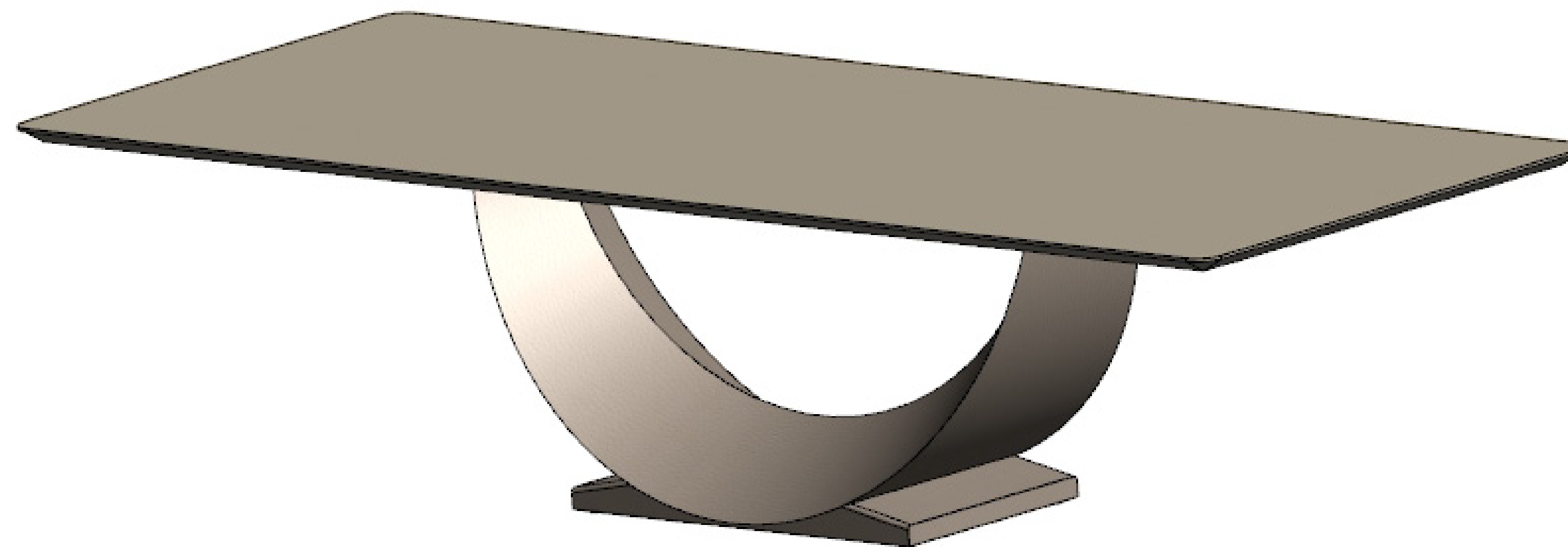

MESA DE JANTAR **Jafa**

COLEÇÃO ISRAEL

BRETON



MATERIAL

Base de mdf revestido em couro,
laterais em couro, tampo revestido
em espelho ou vidro colorido,
bisotê do tampo em laminação facetada.

DIMENSÕES

Largura: 320cm
Profundidade: 120cm
Altura: 76cm

MESA DE JANTAR **BLADE**

COLEÇÃO **CARIBE**

MATERIAL

Aluminio Chumbo

DIMENSÕES

Largura: 220cm
Profundidade: 120cm
Altura: 75cm

BRETON



MESA DE JANTAR IÚNA

COLEÇÃO **CARIBE**

MATERIAL
Aluminio Corten

DIMENSÕES
Largura:150cm
Profundidade:150cm
Altura:73cm



BRETON

MESA DE JANTAR MANTIQUEIRA

COLEÇÃO COLÔMBIA

DESIGNER

Fernanda Marques

MATERIAL

DIMENSÕES

Largura:
Profundidade:
Altura:

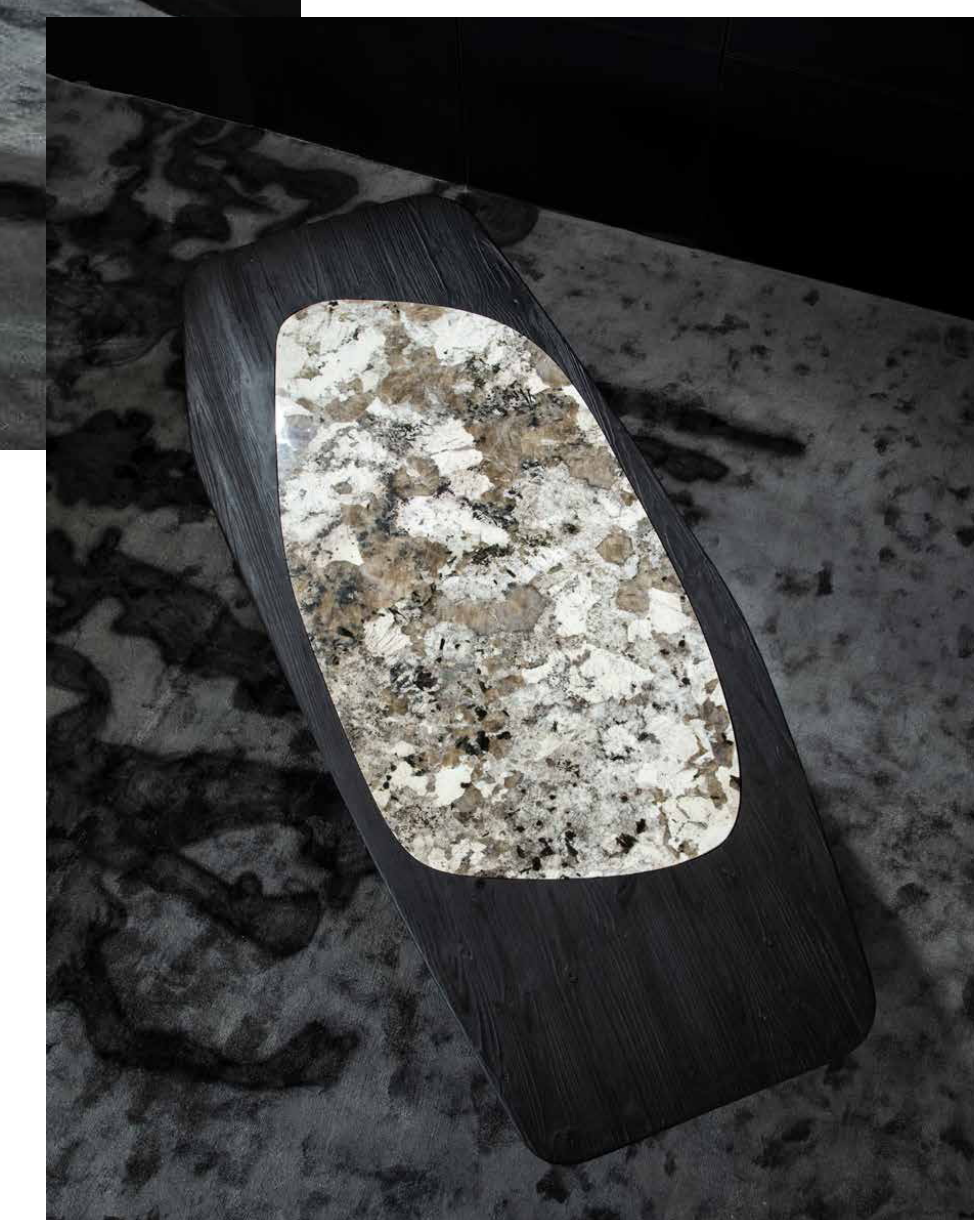

BRETON

BUFFETS E BAR

PRODUTOS
2021

BAR JAZZ

COLEÇÃO BRASIL



DESIGNER
EDU
BORTOLAI

MATERIAL

DIMENSÕES

Largura:
Profundidade:
Altura:

BRETON



BAR NAZARÉ

COLEÇÃO ISRAEL

MATERIAL

Base de mdf revestido em couro,
laterais em couro, tampo revestido
em espelho ou vidro colorido,
bisotê do tampo em laminação facetada.

DIMENSÕES

Largura: 120cm
Profundidade: 50cm
Altura: 120cm

BRETON



BUFFET TRAMA

COLEÇÃO BRASIL



DESIGNER
CAROL GAY

MATERIAL
Estrutura em MDF laminado.
Base em inox polido.
Acabamento lâmina ou laca.

DIMENSÕES
Largura: 223cm
Profundidade: 56cm
Altura: 77cm

BRETON



BUFFET IMBAU

COLEÇÃO BRASIL



DESIGNER

Luisa Moysés

MATERIAL

DIMENSÕES

Largura:
Profundidade:
Altura:

BRETON



BUFFET MILAGRES

COLEÇÃO BRASIL



DESIGNER
Luisa Moysés

MATERIAL

DIMENSÕES

Largura:
Profundidade:
Altura:

BRETON

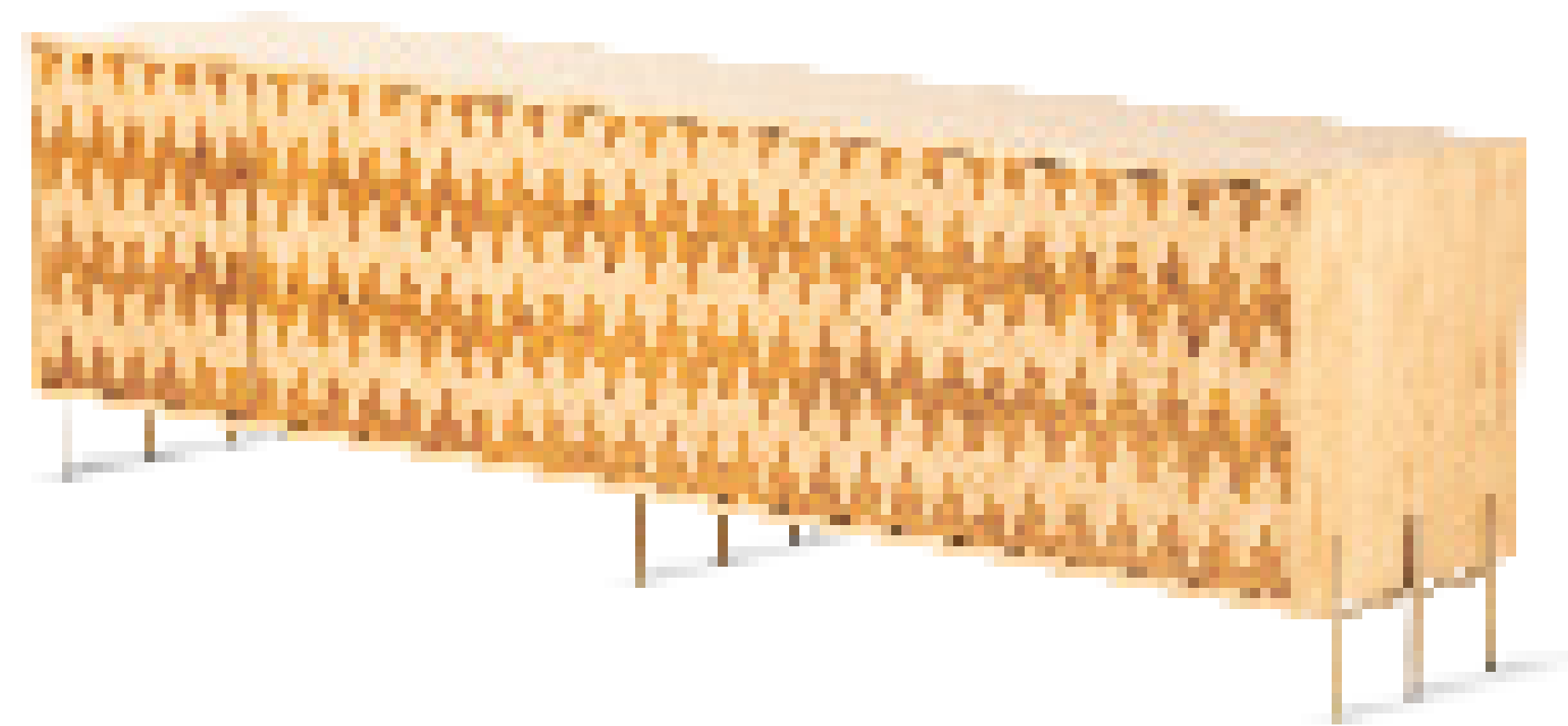

BUFFET **SAN JUAN**

COLEÇÃO **CUBA**



DESIGNER
GRACIA
MENDES

MATERIAL

DIMENSÕES
LARGURA:
PROFUNDIDADE:
ALTURA:



BUFFET TIRAS

COLEÇÃO BRASIL

DESIGNER
Fetische Design

MATERIAL

DIMENSÕES

Largura:
Profundidade:
Altura:

BRETON



BUFFET NAZARÉ

COLEÇÃO ISRAEL

BRETON



MATERIAL

Base de mdf revestido em recouro, laterais em recouro, tampo revestido em espelho ou vidro colorido, bisotê do tampo em laminação facetada.

DIMENSÕES

Largura: 200 até 240cm
Profundidade: 50cm
Altura: 80cm

COMPLEMENTOS

PRODUTOS
2021

ESCRIVANINHA **FUJI**

COLEÇÃO JAPÃO



MATERIAL

Pés em jequitibá ou laca.
Tampo em courissimo ou vidro.
Acabamento em nogueira,
carvalho ou laca.

DIMENSÕES

Largura: 180cm
Profundidade: 50cm
Altura: 71cm

ESPELHO OSAKA

COLEÇÃO JAPÃO

MATERIAL

DIMENSÕES

Largura:
Profundidade:
Altura:



ESPELHO RAINHA

COLEÇÃO CANADÁ



DESIGNER

Reinaldo Lourenço

MATERIAL

DIMENSÕES

BRETON



BALANÇO AKAIA

COLEÇÃO BRASIL

DESIGNER
ALÊ
ALVARENGA

MATERIAL

DIMENSÕES

Largura:
Profundidade:
Altura:

BRETON



BALANÇO ABDUL

COLEÇÃO EGITO

MATERIAL

Estrutura em aço galvanizado tratado.
Revestimento tramado em corda náutica

DIMENSÕES

Largura: 68cm
Profundidade: 68cm
Altura: 43cm



RETON

BALANÇO CAIRO

COLEÇÃO EGITO

MATERIAL

Estrutura em alumínio e pintura eletrostática.
Revestimento tramado em corda náutica

DIMENSÕES

Largura:133cm
Profundidade:82cm
Altura:120cm



BRETON

BALANÇO CURAÇÃO

COLEÇÃO CARIBE

MATERIAL

Al: Marrom Mesclado Corda Preta e
Corda Bronze Tecido Ferrugem

DIMENSÕES

Largura:106cm
Profundidade:105cm
Altura:155cm



BRETON

BANQUETA PORÃ

COLEÇÃO **CARIBE**

MATERIAL

Al: Champagne Micro Corda Areia
Mesclada Tecido Solares Fendi

DIMENSÕES

Largura:55cm
Profundidade:58cm
Altura:100cm



BRETON

CRISTALEIRA JERUSALÉM

COLEÇÃO ISRAEL

MATERIAL

Base de mdf revestido em couro,
laterais em couro, tampo revestido
em espelho ou vidro colorido,
bisotê do tampo em laminação facetada.

DIMENSÕES

Largura: 200 até 240cm
Profundidade: 50cm
Altura: 80cm



BRETON

BAU
NOAH
MEIA LUA
COLEÇÃO CANADÁ



DESIGNER
RAFAEL
PRETO

MATERIAL

CARVALHO EBANIZADO
TOPO EM PALHA SEXTAVA-
DA PRETA
DETALHE LATÃO

DIMENSÕES

LARGURA: 45CM
PROFUNDIDADE: 45CM
ALTURA: 42CM

BRETON



BAU NOAH

COLEÇÃO CANADÁ



DESIGNER
RAFAEL
PRETO

MATERIAL

NOGUEIRA
TOPO EM PALHA SEXTAVADA
NATURAL
DETALHE LATÃO

DIMENSÕES

DIÂMETRO: 45CM
ALTURA : 42CM

BRETON



CABIDEIRO MANDACARU

COLEÇÃO CANADÁ



DESIGNER
ESTEVÃO
TOLEDO

MATERIAL

LACA PRETA
DETALHE EM JASPER

DIMENSÕES

LARGURA: 45cm
PROFUNDIDADE: 45cm
ALTURA: 158cm

BRETON



BANQUETA **BERENICE**

COLEÇÃO **EGITO**

MATERIAL

Estrutura em tubo de aço carbono galvanizado com pintura eletrostática.
Revestimento tramado em corda náutica.

DIMENSÕES

Largura: 50cm
Profundidade: 56cm
Altura: 96cm



BRETON

MANCEBO CARAÍVA

COLEÇÃO BRASIL



DESIGNER
Luisa Moysés

MATERIAL

DIMENSÕES
Largura:
Profundidade:
Altura:



BRETON



MESA DE CABECEIRA **NAZARÉ**

COLEÇÃO ISRAEL

MATERIAL

Base e laterais em couro,
tampo revestido em espelho ou
vidro colorido, bisotê do tampo
em laminação facetada, gavetas
em couro.

DIMENSÕES

Largura: 70 até 100cm
Profundidade: 50cm
Altura: 60cm



BRETON

RECAMIER **MARRE**

COLEÇÃO FRANÇA

BRETON



MATERIAL

DIMENSÕES

HOMES

PRODUTOS
2021

HOME HAVANA

COLEÇÃO CUBA



DESIGNER
GRACIA
MENDES

MATERIAL

ESTRUTURA E RIPAS : MADEIRA MACIÇA
ACABAMENTO : GOFRATTO, LACA FÔSCA
OU BRILHO, NOGUEIRA, FREIJÓ

DIMENSÕES

LARGURA: 136 ATÉ 200CM
PROFUNDIDADE: 45CM
ALTURA: 51,5CM



HOME **SALSA**

COLEÇÃO **CUBA**



DESIGNER
GRACIA
MENDES

MATERIAL

ESTRUTURA : RIPAS SANFONADA
BASE : MADEIRA MACIÇA
ACABAMENTO : FREIJÕ, NOGUEIRA
GOFRATTO, LACA FOSCA E BRILHO

DIMENSÕES

LARGURA: 80 ATÉ 300CM
PROFUNDIDADE: 90CM
ALTURA: 82CM



BRETON

PRODUTOS|
2021